

Geotechnical
Water Resources
Environmental and
Ecological Services

Upstream Fish Passage Alternatives Evaluation - Final Report

Submitted to:
PPL Montana
45 Basin Creek Road
Butte, MT 59701

Submitted by:
GEI Consultants, Inc.
Chadwick Ecological Division
127 East Front Street, Suite 216
Missoula, MT 59802

January 2007
Project 060080

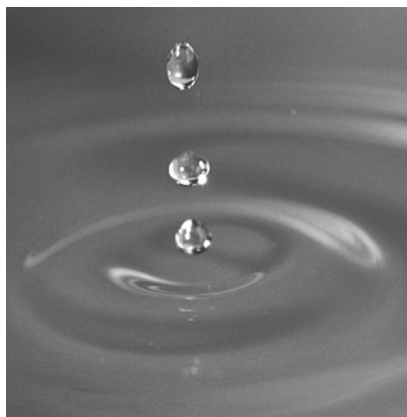

W. Steve Rainey, P.E.

Table of Contents

1.0 Introduction	1
1.1 Report Purpose	2
1.2 Description of Existing Project Facilities	2
1.3 Thompson Falls Fish Passage Plan Description and Schedule	3
2.0 Project Data	6
2.1 Powerhouse Data	7
2.1.1 Old Powerhouse	7
2.1.2 New Powerhouse	7
2.2 Spillway Data	8
2.2.1 Main Dam Spillway	8
2.2.2 Dry Channel Spillway	8
2.2.3 Spillway Operations for Fish Passage	9
2.3 Geotechnical Data	9
2.3.1 Geologic Information	9
2.3.2 Overview of Existing Materials Testing Data	9
2.4 Hydrology	10
2.4.1 Peak Flows	13
2.4.2 Main Dam Spillway Discharge	15
2.4.3 12-month Flow Exceedance Curve	15
2.4.4 Flood Frequency	16
2.4.5 Forebay and Tailwater Rating Curves	17
2.4.5.1 Forebay Pool Fluctuation	17
2.4.5.2 Powerhouse Tailwater Rating Curve	17
2.4.5.3 Main Dam Right Abutment Tailwater Rating Curve	18
2.5 Fisheries Summary	18
2.5.1 Target Species	18
2.5.2 Migration Timing	20
2.5.3 Tailrace Fish Behavior	22
3.0 Alternatives Development	24
3.1 Process Overview	24
3.1.1 Site Selection Process and Letter Report	24
3.2 Design High and Low Project Discharges for Upstream Fishway	25
3.3 Site Structural and Civil Engineering Considerations	26
3.3.1 Right Abutment	26
3.4 Other Design Considerations	27
3.4.1 Ladder Design	28

4.0 Description of Alternatives	29
4.1 Alternative #1, Right Full-Height Ladder	29
4.1.1 Functional Description	29
4.1.2 Hydraulic Considerations	30
4.1.3 Fish Sampling	30
4.1.4 Constructability Issues	31
4.1.5 Operations and Maintenance	31
4.1.6 Advantages of the Right Ladder Alternative:	31
4.1.7 Disadvantages of the Right Ladder Alternative	32
4.2 Alternative #2, Fish Lock	32
4.2.1 Functional Description	32
4.2.2 Fish Transport System	33
4.2.3 Hydraulic Considerations	35
4.2.4 Fish Sampling	35
4.2.5 Constructability Issues	35
4.2.6 Operations and Maintenance	35
4.2.7 Advantages of the Fish Lock Alternative	36
4.2.8 Disadvantages of the Fish Lock Alternative	36
4.3 Alternative #3, Left Full-Height Ladder	37
4.3.1 Functional Description	37
4.3.2 Hydraulic Considerations	38
4.3.3 Fish Sampling	38
4.3.4 Constructability Issues	38
4.3.5 Advantages of Left Ladder Alternative	38
4.3.6 Disadvantages of Left Ladder Alternative	39
4.4 Alternative Cost Estimates	39
5.0 Conclusions	43
5.1 Summary of Discussions	43
5.2 Conclusion	45
6.0 References	46

List of Tables

Table 1	Summary of Main Dam Materials Properties
Table 2	Flood frequency Calculations using log-Pearson Analysis III (period of record 1957-2004) for the Clark Fork River upstream of Thompson Falls Dam

List of Figures

- Figure 1 Location of Thompson Falls Dam and Powerhouse, on the Clark Fork River near Thompson Falls, Montana.
- Figure 2 Topographic map of the Thompson Falls Hydroelectric Project
- Figure 3 Aerial view of Thompson Falls Hydroelectric Project
- Figure 4 Map of USGS gage stations upstream of Thompson Falls Dam utilized to describe local hydrology
- Figure 5 Mean daily flows in the Clark Fork River upstream of Thompson Falls Dam (1994-2004)
- Figure 6 Mean, minimum, and maximum annual hydrograph (1957-2004) of the Clark Fork River
- Figure 7 Peak flow in the Clark Fork River upstream of Thompson Falls Dam from 1957 – 2004. *Source: U.S. Geological Survey*
- Figure 8 Date of peak flow in the Clark Fork River above Thompson Falls Dam
- Figure 9 Mean daily flow (cfs) and spill (cfs) between April 1 and July 30 from 1957-2004
- Figure 10 Annual flow exceedance curve
- Figure 11 Tailwater Rating Curve at Thompson Falls Dam Powerhouse based on flow data from the powerhouse from January 1 through June 5, 2006
- Figure 12 Tailwater Rating Curve at Thompson Falls Dam, right abutment of the Main Dam, based on total spill April – July 2006
- Figure 13 Cumulative number of combined trout (westslope cutthroat, rainbow, brown, and westslope cutthroat x rainbow trout hybrids) captured by date at the Thompson Falls Dam fish trap during 2006. Project spill, i.e. flow in excess of plant capacity which passed over the spillways, is indicated by the blue line and the right Y-axis
- Figure 14 The total number of 15 minute time intervals when signals were recorded by the remote telemetry receivers at Thompson Falls Dam during 2005
- Figure 15 Total number of radio tagged fish, by species, detected in the Thompson Falls Dam tailrace during the first nine months of 2006
- Figure 16 Example fish transport tank
- Figure 17 Example rail line with switches

List of Appendices

Appendix A

Appendix B

1.0 Introduction

PPL Montana owns and operates Thompson Falls Dam, a 92.6 MW hydroelectric project built on the Clark Fork River in 1917 (Figure 1). The Federal Energy Regulatory Commission (FERC) granted a new license for the project to Montana Power (now PPL Montana) in 1979, and amended the license to include a new powerhouse in 1990. In June 1998, the bull trout was listed as a threatened species under the Endangered Species Act (ESA). The westslope cutthroat trout is considered a Species of Special Concern by the State of Montana and the Montana Chapter of the American Fisheries Society and the U.S. Forest Service considers it a sensitive species. In 2003, a biological evaluation was prepared to assess the impacts that Thompson Falls Dam and Powerhouse may be having on bull and westslope cutthroat trout and to make recommendations about possible conservation measures to reduce those impacts.

The biological evaluation concluded that, among other impacts, the dam blocks upstream fish passage at all times of the year and that this project is likely adversely affecting bull trout. Additionally, the project may be impacting individuals and habitat of westslope cutthroat trout and may be contributing toward a trend toward federal listing due to a decrease of viability of local populations. One of the conservation measures proposed was to implement an upstream fish passage research and development program.

In response to the conclusions of the biological evaluation, a Pre-design Phase Fish Passage Study Plan was finalized in 2003. One of the first steps identified in the fish passage study plan was a fish behavior study of fish behavior in the tailrace of Thompson Falls Dam. The fish behavior study was initiated in 2004, and will continue through 2006. Results of this study are summarized in Section 2.5.

Additionally, the Pre-design Phase Fish Passage Study Plan called for evaluations of hydrology, hydraulics, operational constraints, site configuration, and attraction water supply. This report includes discussion of all of these factors in an assessment three of potential fishway alternatives.

Planning for fish passage is being coordinated through an Interagency Technical Coordination Group (Interagency Group). This report was initially prepared in draft in September 2006, and presented to PPL Montana and the Interagency Group. The Interagency Group met with PPL Montana and GEI on October 5, 2006, in Thompson Falls to review the results of the report, tour the project site, and make a recommendation about the preferred alternative. Notes from that meeting, and the consensus conclusion for the preferred alternative (right bank full height ladder), have been added to this final report in Section 5.

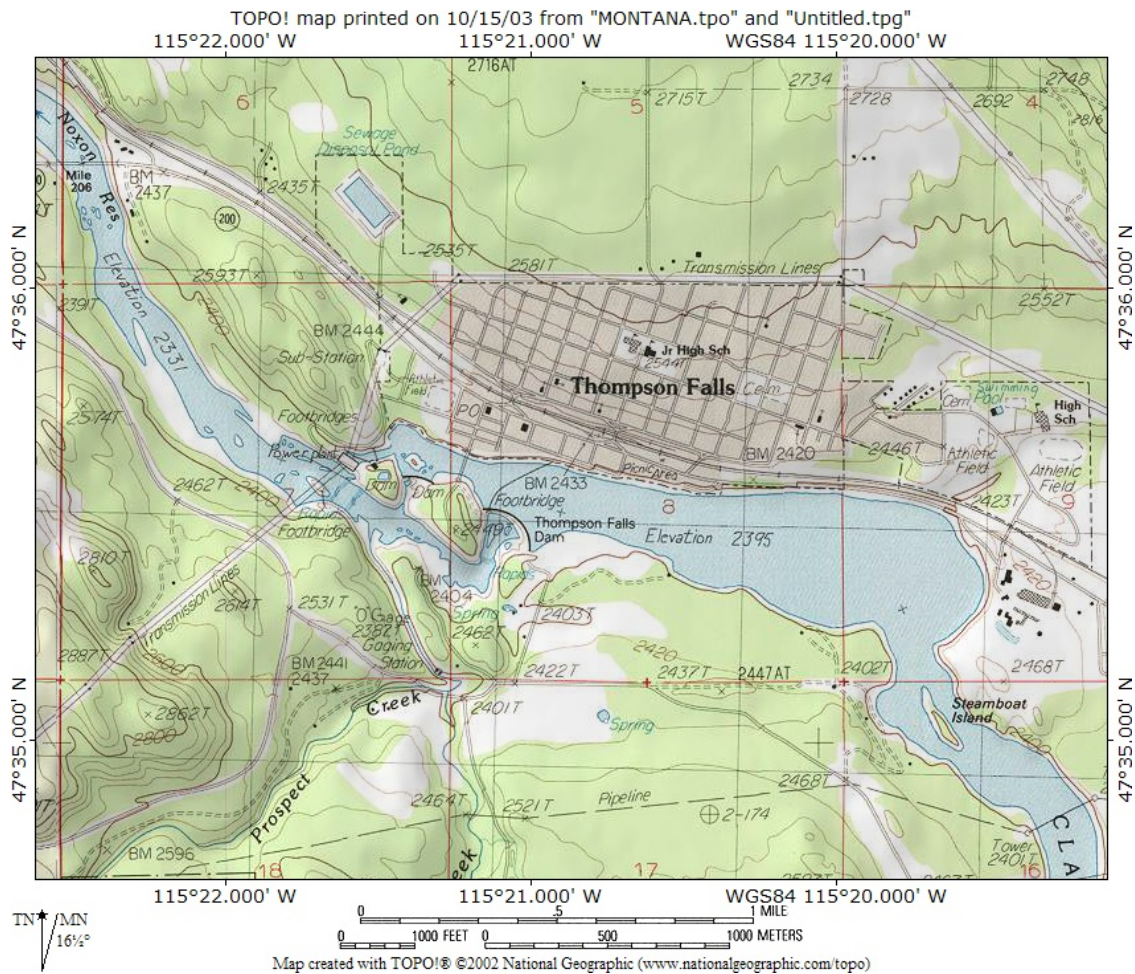

Figure 1 Location of Thompson Falls Dam and Powerhouse, on the Clark Fork River near Thompson Falls, Montana.

1.1 Report Purpose

Three fishway alternatives were preliminarily prepared for review by the fish agencies: a right abutment full-height ladder, a right abutment fish-lock, and a left abutment full-height ladder. This draft feasibility study incorporates agencies feedback on initial fishway options, includes the latest topographic survey information, and incorporates additional site investigation results. This report, in conjunction with the reports on fish behavior, will be used to select a preferred alternative for the fishway design.

1.2 Description of Existing Project Facilities

The Thompson Falls Project consists of: 1) a concrete gravity arch Main Dam, approximately 1,016 feet long and 54 feet high; 2) a concrete gravity auxiliary dam known as the Dry Channel Dam, approximately 449 feet long and 45 feet high; 3) a 1,446- acre,

12-mile-long reservoir with a usable storage capacity of 15,000 acre-feet (ac-ft); 4) a 450-foot-long, 80-foot-wide intake channel cut through rock; 5) a steel framed and masonry powerhouse containing six generating units with a total capacity of 40 megawatts (Mw); 6) an additional powerhouse, built in 1994, containing one generating unit with a capacity of 52.6 Mw; 7) a 75-foot-wide, 300-foot-long intake channel; 8) a 1,000-foot-long tailrace channel, 9) a 1,000-foot access road; 10) a 360-foot-long bridge (FERC, 1990; FERC, 1994). The project operates at about 62 feet of maximum head with headwater at 2,397 feet and tailwater at 2,335 feet depending on discharge and flashboard/reservoir conditions. More typical operating heads are around 59 feet (PPL Montana Operators).

1.3 Thompson Falls Fish Passage Plan Description and Schedule

The Pre-design Phase Fish Passage Study Plan laid out a series of activities that would, if appropriate, lead to the design and construction of an upstream adult fishway at Thompson Falls Dam. Since this plan was written, in 2003, several modifications to the plan and schedule have been developed. The schedule below represents the anticipated next steps in adult upstream fishway development. Other issues, such as downstream fish passage and TDG, will be addressed on a parallel track.

Summary report 2004 – 2005 fish behavior: GEI prepared a summary report that describes what we have learned about fish behavior in the tailrace at Thompson Falls to date.

Completion January 27, 2006

Upstream fishway site selection: GEI assessed the optimum site for an upstream fish passage facility, using the summary fish behavior report and photographic information. Steve Rainey prepared a memo report which would list rationale for selecting the optimum site. *Completion January 27, 2006.*

Interagency coordination: Interagency technical advisory group discussed the results of the 2005 studies, and plans for the coming year. *January 2006.*

Develop 2006 study plan: Develop a written plan describing what we intend to do in 2006. The draft was submitted to the Interagency group for comment in January. The final plan (this document) was prepared in response to comments. *Complete draft before January 27, 2006, and final by March 31, 2006.*

Tour of Columbia Basin Fishways. Interagency tour of dams with fish passage facilities in the Columbia River basin. *April 2006.*

Alternatives evaluation: Once the tentative best site has been selected, initiate an alternatives study for that site. The several options include trap and haul options with a lock, a hopper, and the non-trap, full-height ladder options. Develop costs estimates within 30-40

percent. Coordinate with all parties. *Initiate Early 2006 and complete draft by September 8, 2006. Finalize January 2007.*

Interagency coordination: Interagency technical advisory group meeting on site to tour the facility and discuss the results of the spring 2006 studies. *June 2006.*

Select preferred alternative(s): The interagency technical advisory group meeting on site to tour the facility at low flows and discuss the results of the feasibility study to agree on a preferred alternative. *October 5, 2006.*

Preliminary Design: Develop preliminary design of the preferred alternative(s). Conduct additional site investigations, size primary features, complete site plan, coordinate with all parties. *Complete draft for comment early 2007.*

Comments on Preliminary Design: *Early Spring 2007. Complete final preliminary design report by Spring 2007*

Prepare plans and specifications: Develop final design and prepare specifications for bid solicitation. *Begin 2007*

Finish plans and specifications:
December 2007

Final fish passage plan and biological assessment:
August 2007

USFWS Final biological opinion:
Feb 2008

Application to amend license:
April 2008

Final FERC Order:
October 2008

COE and State permits:
January 2009

Start construction:
Spring 2009

Complete construction:
Fall 2010

2.0 Project Data

The 92.6 MW Thompson Falls Hydroelectric Project features include an old powerhouse, new powerhouse, Dry Channel spillway, and the Main Dam spillway. Each are separated by islands (Figures 2 and 3). The distance from the downstream end of the old powerhouse upstream to the Main Dam (spillway) is approximately one-half mile.

The following is a brief description of primary project features.

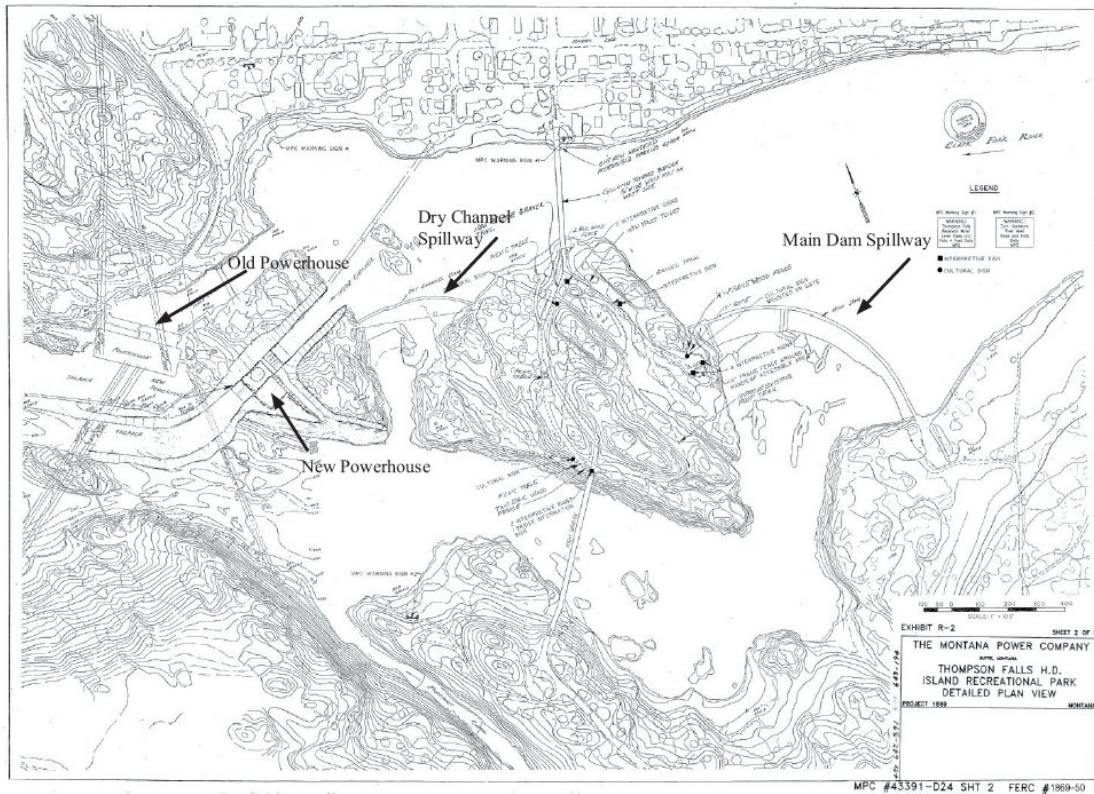

Figure 2 Topographic map of the Thompson Falls Hydroelectric Project



Figure 3 Aerial view of Thompson Falls Hydroelectric Project

2.1 Powerhouse Data

2.1.1 Old Powerhouse

The original, downstream-most right bank powerhouse is composed of six Francis turbines rated at 5 MW each, each with hydraulic capacities of 1,700 cubic feet per second (cfs). Total turbine capacity is 10,200 cfs. Powerhouse maximum operating head is 62 ft at both powerhouses. Two of these old units provide station service. A large wingwall (located parallel to the river centerline) protects the powerhouse structure from high river discharges, and routes turbine discharge directly down river and along the shoreline immediately downstream of the powerhouse.

2.1.2 New Powerhouse

The new powerhouse is immediately upstream of the old powerhouse, and has one large Kaplan turbine, rated at 62 MW, with a capacity of approximately 13,000 cfs. As the newest and most efficient turbine, it is the first unit on, and last off, during normal operations. When discharge is less than 13,000 cfs, the new powerhouse is preferentially operated to maximize peak efficiency of the project. Two units, typically Nos. 1 and 3, are operate as auxiliary power to No. 7 to maintain heat in the old powerhouse and to exercise these other

units during low flows. Units 2,4,5, and 6 are operated at high flows, as they are the least efficient and smallest units at the project.

2.2 Spillway Data

2.2.1 Main Dam Spillway

Once powerhouse capacity is exceeded, spill is initiated at the Main Dam. This feature is furthest upstream, and is located in the original river channel (immediately above the original falls). The spillway has 36 spill bays, with 34 bays having six manually-operated spill panels (lift panels) each (Figure A.1, in Appendix A). Two large center-dam radial gates compose spill bays 16 and 17. They are each 41 ft wide, and a capacity of approximately 11,000 cfs. Their primary functions are to keep the forebay at a constant elevation at night during the spring (on the rising hydrograph), until operators can adjust the required lift panel numbers the next day; and, to maintain reserve emergency load-rejection capacity. Lift panels (4 ft wide and 8 ft high), and are manually raised and lowered during daylight hours by a tracked lift. Each panel passes 233 cfs. The 10-12 panels to the right of the two radial gates are near the forebay trash boom tied to the dam, and are rarely opened. Project operators try to balance lift panel openings on each side of the trash shear boom, which minimizes excessive lateral hydraulic loading and limits boom problems.

The capacity of 192 spill panels is approximately 47,532 cfs. Flow from each lift panel spreads laterally as it passes down the spillway face and onto a concrete apron, before passing into the bedrock-lined tailrace channel.

Underneath the lift panels are eight, 1-ft high wood bulkheads. In years when total river discharge is expected to exceed 100,000 cfs during the spring freshet, there is a need to increase spillway capacity. A special operation removes bulkheads before the spill season, and they remain removed until after high runoff subsides. (This will have an unknown effect on upstream fish passage; however, adverse impacts may be avoidable if stoplogs near the selected fishway remain closed.) During normal and low runoff years, these bulkheads are not opened. Total Main Dam spill capacity, with all lift panels opened and without bulkheads opened, and including the two radial gates, is approximately 69,500 cfs. Currently, uncontrolled leakage of bulkheads (below spill panels) varies (depending on status of manual efforts to block leakage) can total up to approximately 200 cfs.

2.2.2 Dry Channel Spillway

This smaller spillway is between the new powerhouse and Main Dam spillway, and is separated from each by islands. It is only operated when additional spill capacity, above that of the Main Dam spillway, is exceeded. The Dry Channel has 72 total lift panels (similar to

those at the Main Dam), and a capacity of 16,776 cfs. Total spill capacity of the two spillways, without removing Main Dam bulkheads, is approximately 86,000 cfs.

2.2.3 Spillway Operations for Fish Passage

A spillway operating schedule was developed for the 2006 radio-telemetry study, to determine whether tailrace hydraulic conditions could be manipulated to influence where fish hold in the Main Dam spillway tailrace. It was determined that this operating schedule was not detrimental to project operations, and helped attract fish to the right abutment tailrace area (where two of three fishway alternatives are being considered). This spill schedule is a living document, and can be changed at any time to reflect additional appropriate fisheries or operational input. The principle is that three initial attraction lift panels are opened to attract fish to the right abutment tailrace area during low spill, then lift panels at the left abutment (starting at Spill Bay 36) are opened sequentially to the right – thereby creating a turbulent zone at the left spillway that pushes fish to the right. The most current spill schedule (dated December 6, 2006) is in Appendix B.

2.3 Geotechnical Data

2.3.1 Geologic Information

The regional geology in the vicinity of the Thompson Falls dam and hydroelectric facilities is underlain by the Precambrian Wallace Formation and topped with sands, gravels, and cobbles of the Quaternary Alluvium. The Wallace Formation at the Main Dam abutments and foundation consist primarily of argillite, a metamorphic rock which is intermediate between shale and slate, lacking true slaty cleavage. The argillite at the Main Dam is described as being grey to green in color, hard, massive to blocky, jointed, thinly bedded with high angle fractures. The rock dips upstream at the dam location.

2.3.2 Overview of Existing Materials Testing Data

In October of 1993, a materials testing program was conducted at the Main Dam and Dry Channel Dam to supplement previous studies. Three holes were cored through the crest of each structure with an HQ wireline system into the foundation bedrock. The primary objective of the testing program was to support strength parameters used in earlier stability analyses. Cores in the concrete, argillite, and at the concrete/argillite interface were tested for unit weight, unconfined compressive (UC) strength, and direct shear strength. Table 1 summarizes the materials properties from the 1993 Materials Testing Program prepared by Montana Power Company.

Table 1 Summary of Main Dam Materials Properties

Material	Min. Unit Wt. (pcf)	Max Unit Wt. (pcf)	Avg Unit Wt. (pcf)	Min. UC Strength (psi)	Max UC Strength (psi)	Avg. UC Strength (psi)
Concrete	144.3	150.4	148.3	3,430	4,640	3,977
Argillite	168.2	171.5	169.9	15,120	17,810	16,465

Laboratory testing also determined that the bond strength between the concrete and argillite exceeded the strength of the concrete. A conservative recommendation of strength parameters was recommended based on the smallest strength envelope for the concrete, the lowest strength material. The Materials Testing Program recommended using a cohesion value of 245 psi and a friction angle of 56 degrees in future structural analyses.

2.4 Hydrology

The main hydrologic contributions upstream of the Thompson Falls Dam include the lower Flathead River and Clark Fork River. These two systems meet near Paradise, Montana approximately 35 river miles upstream of Thompson Falls Dam.

Flow in the Clark Fork River is essentially unregulated. Several small dams are present in headwater areas, but none of them have significant storage or diversion. The hydrograph of the Clark Fork River is driven by meteorological conditions.

The lower Flathead River is regulated by Kerr Dam at the outlet of Flathead Lake and Hungry Horse Dam on the South Fork of the Flathead River. Current operational restrictions at Kerr Dam include minimum instream flows, which vary over the year, and limits on the amount of flow fluctuation allowed.

Hungry Horse Dam is located on the South Fork of the Flathead River, upstream of Flathead Lake. This project was completed in 1953. The [Hungry Horse Reservoir](#) has 2,982,000 acre feet of capacity assigned to flood control. Hungry Horse Dam contributes materially toward controlling floods on the Columbia River.

In general, peak flows in the Flathead River are reduced by the presence of the storage dams while baseflows are increased over what would have been present under pre-dam conditions. However, this effect is attenuated at Thompson Falls because of the influence of the unregulated Clark Fork River.

Several U.S. Geological Survey (USGS) gage stations were used to describe the hydrology upstream of Thompson Falls Dam (Figure 4). USGS gage stations including the lower Flathead River at Perma (gage #12388700); the Clark Fork River at St. Regis (gage #12354500), located upstream of the confluence of the Flathead River and the Clark Fork River; the Clark Fork River at Plains (gage #12389000), located downstream of the confluence of the Clark Fork River and the Flathead River; and the Thompson River (gage

#12389500). Note that graphs and discussions regarding flow measurements representing the Clark Fork River upstream of the Thompson Falls Dam include the combination of two USGS gage stations, Thompson River and Clark Fork in Plains.

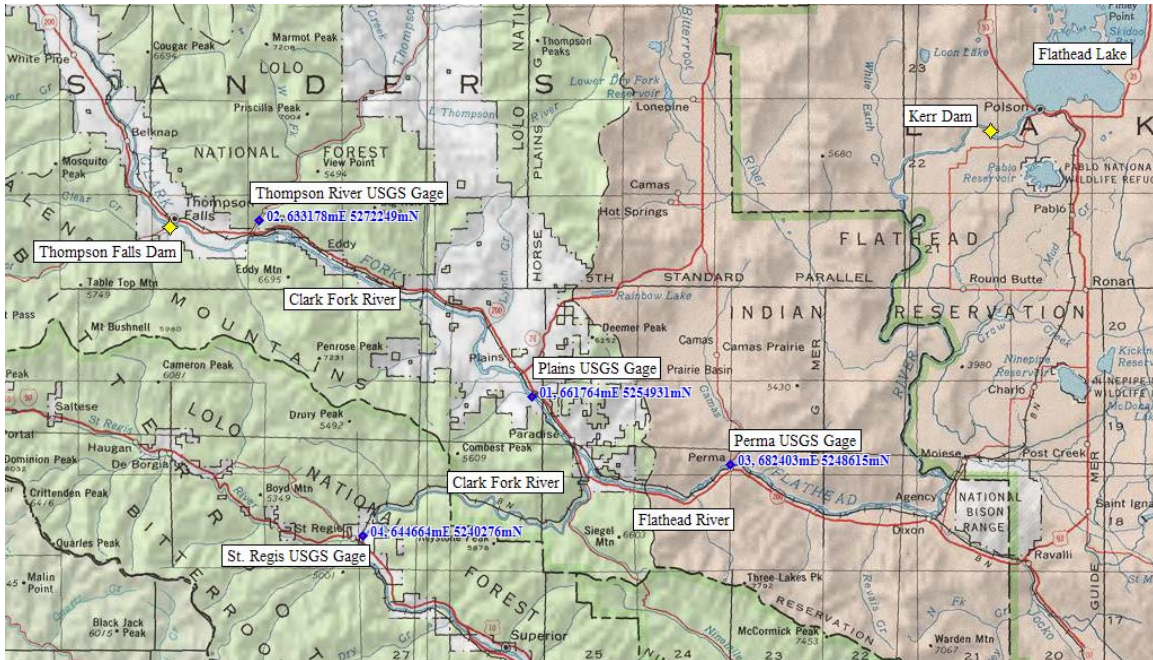

Figure 4 Map of USGS gage stations upstream of Thompson Falls Dam utilized to describe local hydrology

While this section briefly describes the annual hydrological characteristics of the Clark Fork River, the main hydrologic period of concern coincides with the upstream migration of bull, westslope cutthroat, and rainbow trout, which occur generally during the ascending limb of the hydrograph. Thus, the following information primarily focuses on the period between March and June (1994-2004).

Mean daily flows in the Clark Fork River just upstream of the Thompson Falls Dam (measurement includes gage information from Plains plus Thompson River) from 1994-2004 are shown below in Figure 5. Relatively higher flow years (peak > 75,000 cfs) include 1996, 1997, and 2002. Relatively lower flow years (peak < 45,000 cfs) include 1994, 2000, 2001, and 2004.

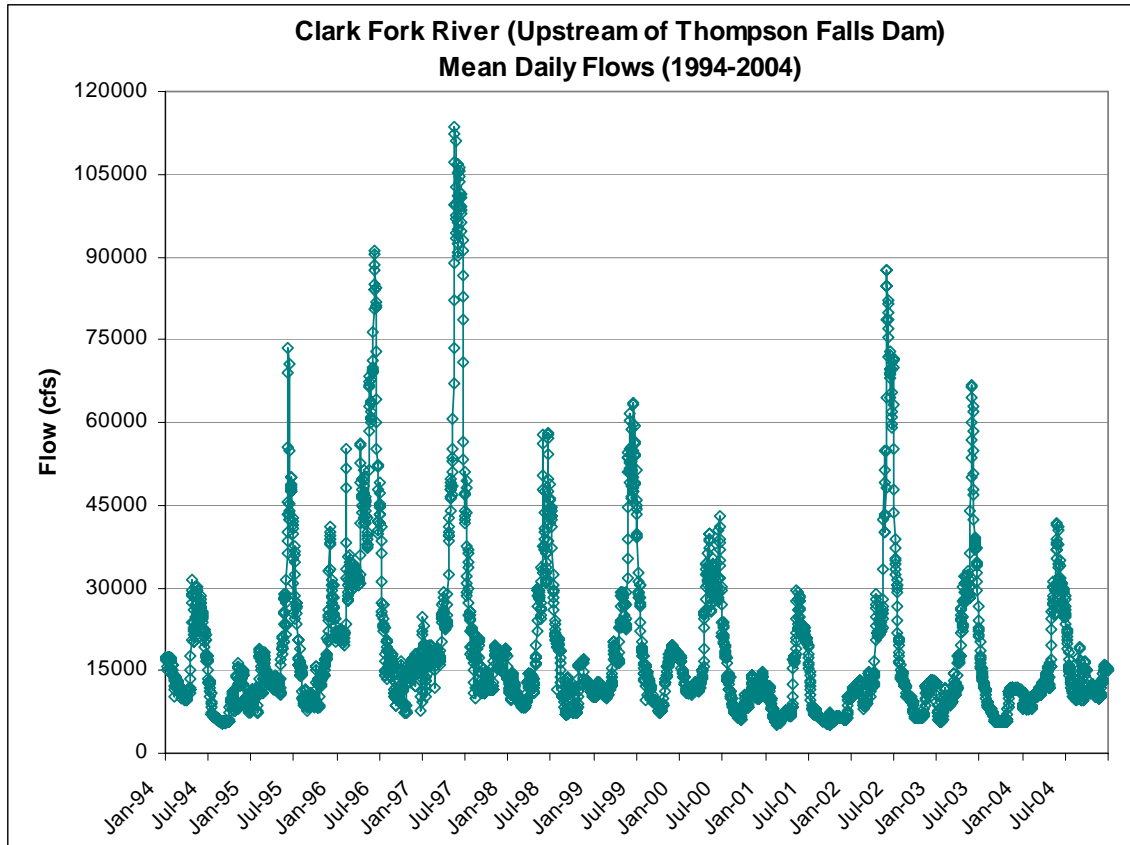

Figure 5 Mean daily flows in the Clark Fork River upstream of Thompson Falls Dam (1994-2004)

In the last 10 years, the highest peak flow neared 120,000 cfs in spring of 1997 and the lowest peak flows were near 30,000 cfs in 1994 and 2001. These drastic changes in flows from year to year do not appear to be related to regulated flow at Kerr Dam, but are climatic conditions and observed in flow from both the Flathead River and Clark Fork River drainages upstream.

Flow patterns of the Clark Fork River just upstream of Thompson Falls Dam are best represented by a combination of measurements taken from the Thompson River (USGS gage #12389500) and the Clark Fork River near Plains (USGS gage #12389000). Concurrent measurements from these two USGS gage stations were available from 1957 to 2004. These data were used to develop flow exceedance curves, a flood frequency curve, an annual discharge curve based on mean daily flows, peak flows, and depict spillway discharges at the Main Dam.

The annual hydrograph of the Clark Fork River just upstream of Thompson Falls Dam from 1957 to 2004 is shown in Figure 6 represents addition of flows taken from USGS gages on the Clark Fork River near Plains (#12389000) and downstream on the Thompson River (#12389500). The annual hydrograph shows the minimum, mean, and maximum annual

flows over a 48 year period. The annual hydrograph indicates the ascending limb of the hydrograph begins between mid- and late March, peaks between late May and mid-June, and descends achieving base flows around mid-August. Of course these trends may vary on dry or wet years, but on average Figure 6 portrays expected hydrology in the Clark Fork River upstream of Thompson Falls Dam.

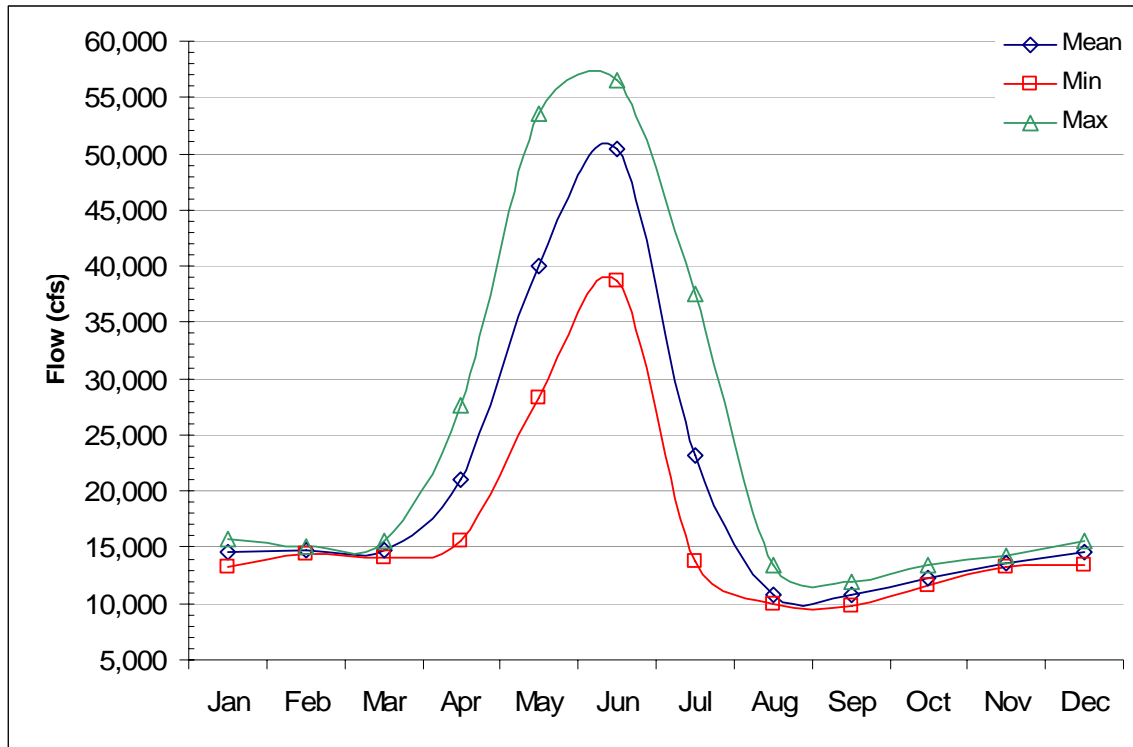

Figure 6 Mean, minimum, and maximum mean monthly flow (1957-2004) of the Clark Fork River *Source: U.S. Geological Survey*

2.4.1 Peak Flows

Peak flows from 1957-2004 upstream of the Project are depicted in Figure 7. The average peak flow is about 73,000 cfs with a standard deviation of about 26,000 cfs.

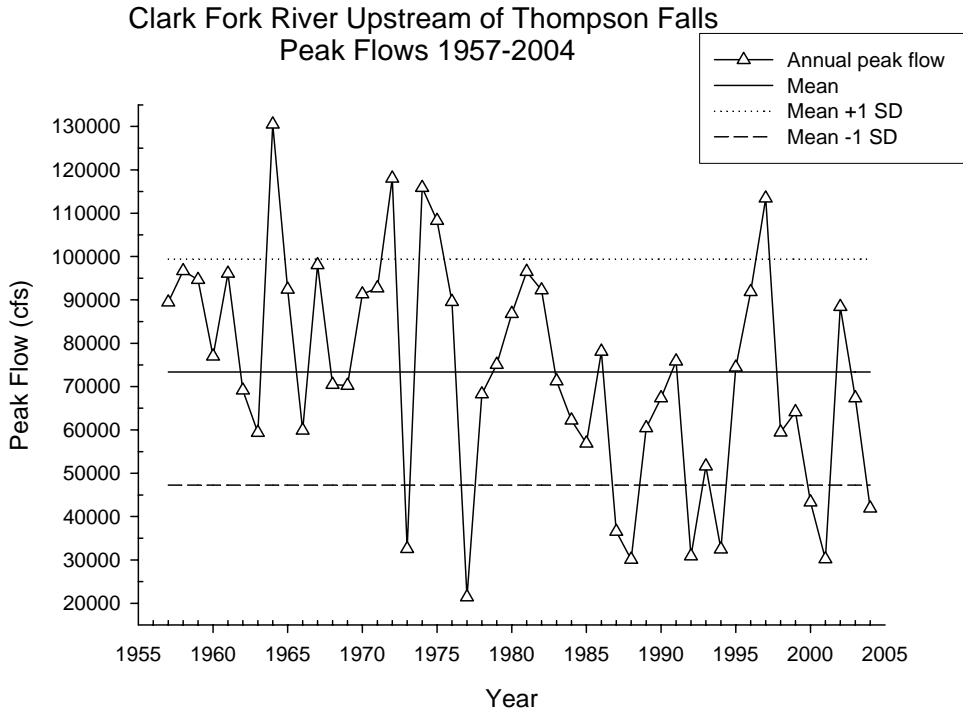

Figure 7 Peak flow in the Clark Fork River upstream of Thompson Falls Dam from 1957 – 2004. *Source: U.S. Geological Survey*

Based on 1957-2004 flow data, peak flows at the Project occur on average on May 31 (Figure 8). During this same period of record, the earliest peak occurred on April 26, 1994 and the latest peak occurred on June 23, 1984.

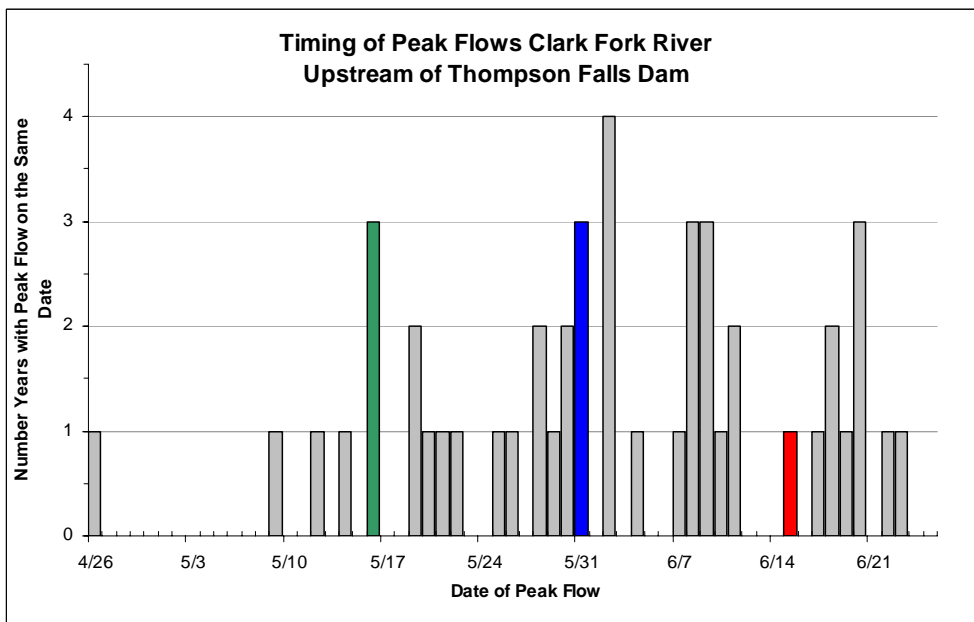

Figure 8 Date of peak flow in the Clark Fork River above Thompson Falls Dam

2.4.2 Main Dam Spillway Discharge

When flows exceed powerhouse capacity (23,000 cfs), the remaining flow is spilled. As shown in Figure 9, on average, spill occurs between April 22 and July 15.

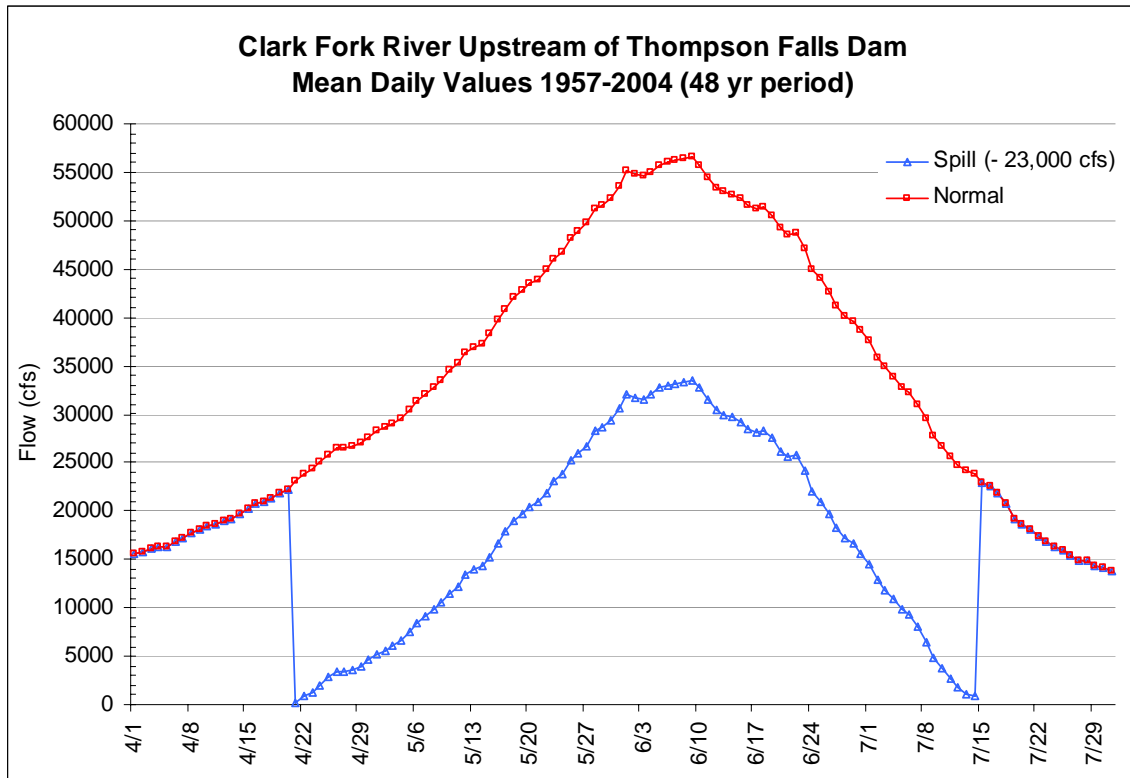

Figure 9 Mean daily flow (cfs) and spill (cfs) between April 1 and July 30 from 1957-2004

2.4.3 12-month Flow Exceedance Curve

The flow exceedance curve shows the percentage of time that flow is equaled or exceeded. The annual flow exceedance curve for the Clark Fork River is shown in Figure 10. This shows that flow exceeds powerhouse capacity (23,000 cfs) approximately 16 percent of the time on an annual basis. Monthly flow exceedance curves for February – June are presented in Appendix C.

Clark Fork River (1957-2004) Upstream of Thompson Falls Dam
12-Month Exceedance Curve

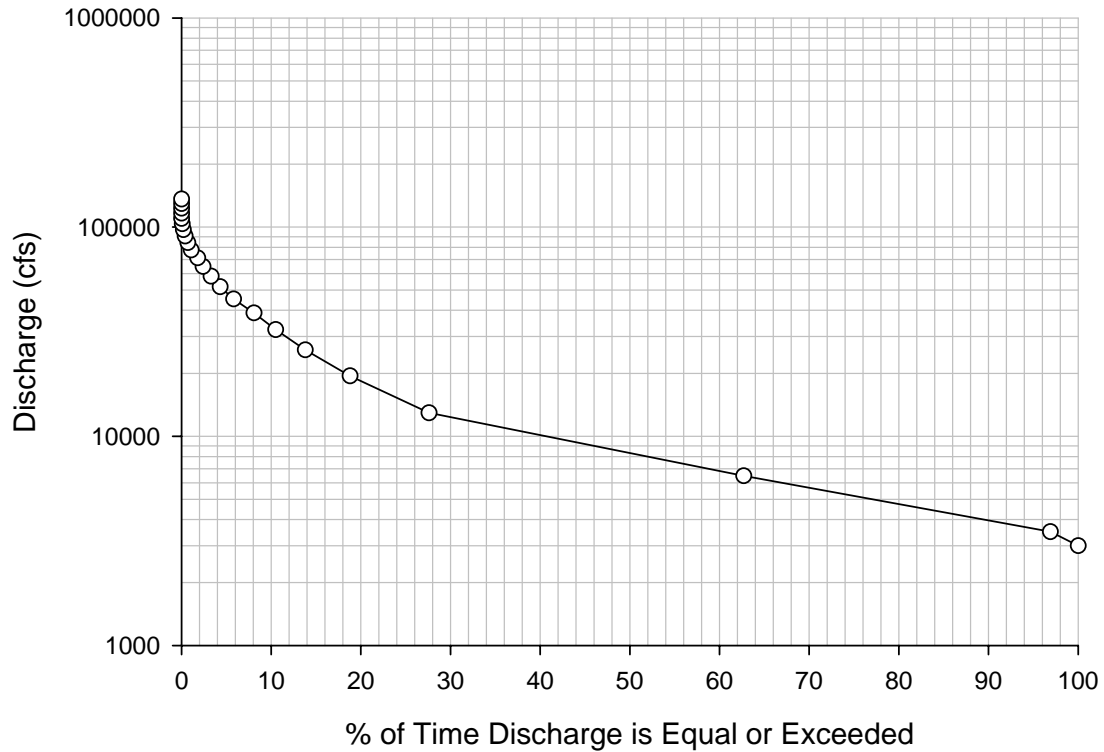

Figure 10 Annual flow exceedance curve

2.4.4 Flood Frequency

The return interval for floods was calculated for the Clark Fork River at Thompson Falls, the results are shown in Table 2.

Table 2 Flood frequency Calculations using log-Pearson Analysis III (period of record 1957-2004) for the Clark Fork River upstream of Thompson Falls Dam

Return Period (years)	Skew Coefficient K(-0.285)	Discharge Q (cfs)
2	0.064	75,374
5	0.856	105,068
10	1.234	123,159
25	1.611	144,316
50	1.843	159,059
100	2.041	172,834
200	2.214	185,853

2.4.5 Forebay and Tailwater Rating Curves

Forebay and tailwater rating curves are required to determine the number of required pools in a full-height fish ladder, with the greatest instantaneous static head as the critical design condition.

2.4.5.1 Forebay Pool Fluctuation

The Thompson Falls forebay is operated within a few tenths of a foot of el 2396.0 for most of the year. During spill periods, forebay elevation can be up to 1.0 ft higher, without automated opening of one (or two) large radial gates at Spill Bays 16 and 17 of the Main Dam spillway.

2.4.5.2 Powerhouse Tailwater Rating Curve

Figure 11 is the tailwater rating curve for the two powerhouses, and relates tailwater elevation to full project discharge (including spillway and powerhouse discharges). Note that at higher powerhouse tailwater elevations (total river discharges), the river backs up and backwaters to Main Dam tailrace.

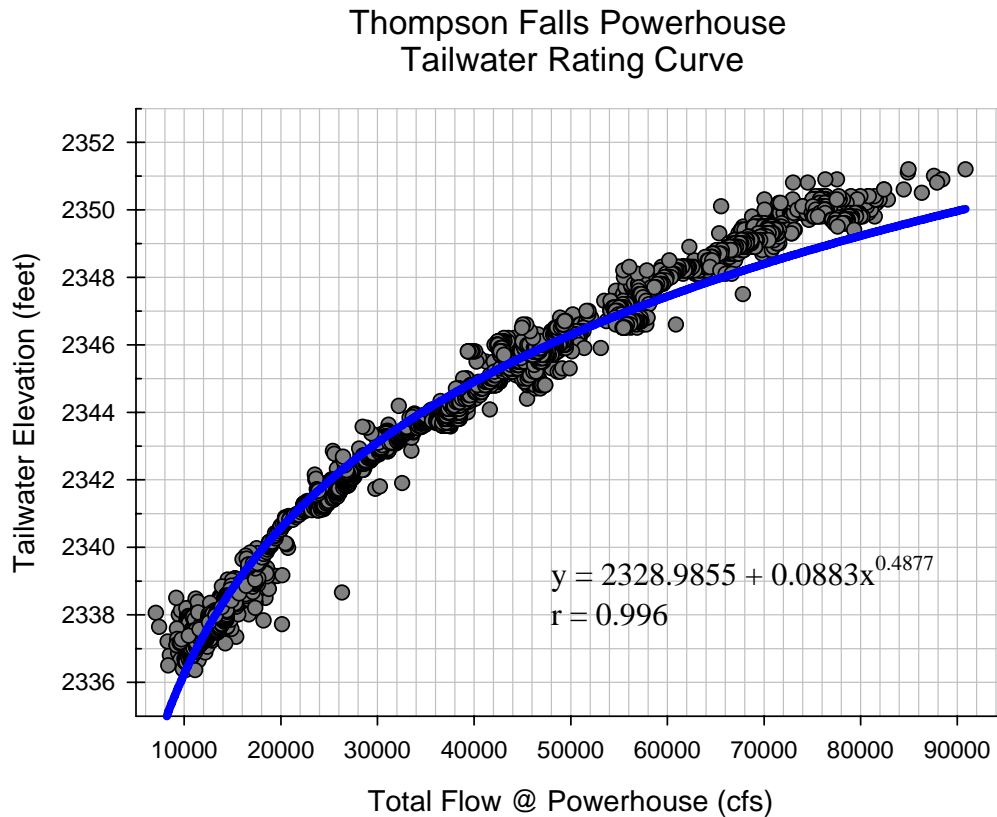

Figure 11 Tailwater Rating Curve at Thompson Falls Dam Powerhouse based on flow data from the powerhouse from January 1 through June 5, 2006

2.4.5.3 Main Dam Right Abutment Tailwater Rating Curve

Figure 12 is the tailwater rating curve for the Main Dam spillway right abutment. It differs from the powerhouse curve, in that it refers to spill at the Main Dam (not total discharge), and the tailwater locations are not the same. This tailwater curve is the basis for the design of the right bank full-height ladder and lock options.

Thompson Falls Right Abutment Tailwater Rating Curve

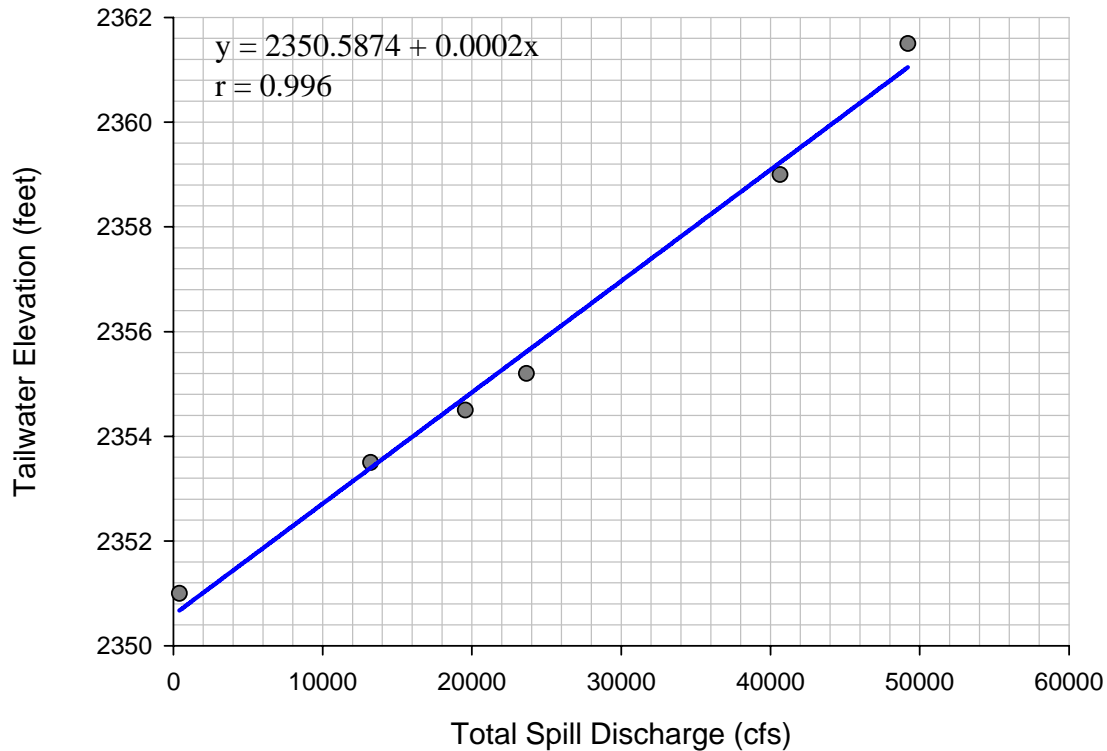

Figure 12 Tailwater Rating Curve at Thompson Falls Dam, right abutment of the Main Dam, based on total spill April – July 2006

2.5 Fisheries Summary

2.5.1 Target Species

The Clark Fork River in the project area contains a variety of native and non-native fish species. Many of these species are migratory and may benefit from upstream fish passage at Thompson Falls Dam. In the Thompson Falls Dam Pre-design Phase Fish Passage Study Plan, prepared in 2003, GEI identified the need to select the target species for fish passage as one of the critical pre-design data requirements. This decision has an effect on the design of the fishway in terms of the seasons when it would be operational, the volume of fish that the fishway would need to handle, and the presence or absence of fish handling facilities.

Data collection to date has been based on the assumption that bull trout will certainly be a target species, but the other native and non-native game species could also be target species. Westslope cutthroat are considered a sensitive species by the U.S. Forest Service and a Species of Special Concern by the State of Montana and the Montana Chapter of the American Fisheries Society. Because of their special status, this species was likely to be a target species of the fish passage program. Non-native brown and rainbow trout provide a significant recreational fishery in western Montana and the Clark Fork River. Because of their status as important game fish they are also potential target species. Other native, non-game species that have been found to have significant migratory movements are longnose and largescale sucker, peamouth, and northern pike minnow.

In July 2006, the U.S. Fish and Wildlife Service and Montana Fish, Wildlife and Parks clarified their positions on target species for the upstream fishway at Thompson Falls.

The USFWS stated that the target species and size ranges appropriate for Thompson Falls are: bull trout, westslope cutthroat trout, and mountain whitefish, over 4 inches in length. They feel that if the State of Montana advocates the passage of nonnative salmonids (e.g., brown trout and rainbow trout) in order to advance recreational fishery objectives, they do not object so long as passage of those species does not hamper bull trout recovery. That can be determined as the project progresses. The USFWS envisions a separating facility will be incorporated in the design in order to retain management flexibility to maximize the target species.

The FWP goal for waters upstream from Thompson Falls Dam is to maintain and enhance native fish as much as possible and to enhance recreational fishing in general, including nonnative trout, in the recruitment-limited middle Clark Fork River. Specifically:

- Full fish passage, particularly for salmonids, is the long-term FWP goal. Except for walleye, the same species are established upstream and downstream from the dam. Disease and genetic risks appear to be minimal at this time. Fish passage would have to be reevaluated if the disease status in Noxon Rapids or Cabinet Gorge reservoirs changed.
- Walleye have been documented upstream but do not yet appear to be self-sustaining. FWP prefers passage be designed so walleye can be excluded. However, the ability of walleye to successfully colonize the Clark Fork River above the dam appears limited. For this reason, some sort of trap and handling facility is needed to monitor walleye (and other species) movement through passage facilities.

Based on comments received from these two agencies, it is clear that the target species of the upstream fishway at Thompson Falls Dam, at least initially, will be all salmonids, both native and non-native. In addition, there may be some interest in passing other non-salmonid species, although this appears to be a lower priority. Fish sorting facilities will be needed to allow for the removal of walleye and other undesirable species.

2.5.2 Migration Timing

Data on the timing of upstream fish migrations into the dam tailrace are available from two sources: the fish trap that has been in place, seasonally, at the Main Dam, since 2001 and the radio tracking study that has been on-going since 2004.

The utility of the fish trap data are limited by the short season when the trap is operational. The trap is typically deployed in mid- March and then removed prior to spill. It can be reinstalled after spill, but at this time of the year water temperatures are generally too warm for safe daytime operation. The number of salmonids collected in the trap over time in 2005 is depicted in Figure 13. In 2005, most of the salmonids caught in the trap were collected during the month of April.

The radio telemetry study provides year-round data on the movement of fish in the tailrace. This study has confirmed that salmonids enter the tailrace of the dam in the early spring, beginning in March. The peak number of salmonids in the tailrace occurs in April and May (Figure 14). During the peak of the hydrograph, the numbers of fish in the tailrace, especially at the Main Dam, declines. Although some salmonids remain in the project area in the vicinity of the mouth of Prospect Creek through the summer and fall, relatively few fish make forays to the Main Dam at this time of the year.

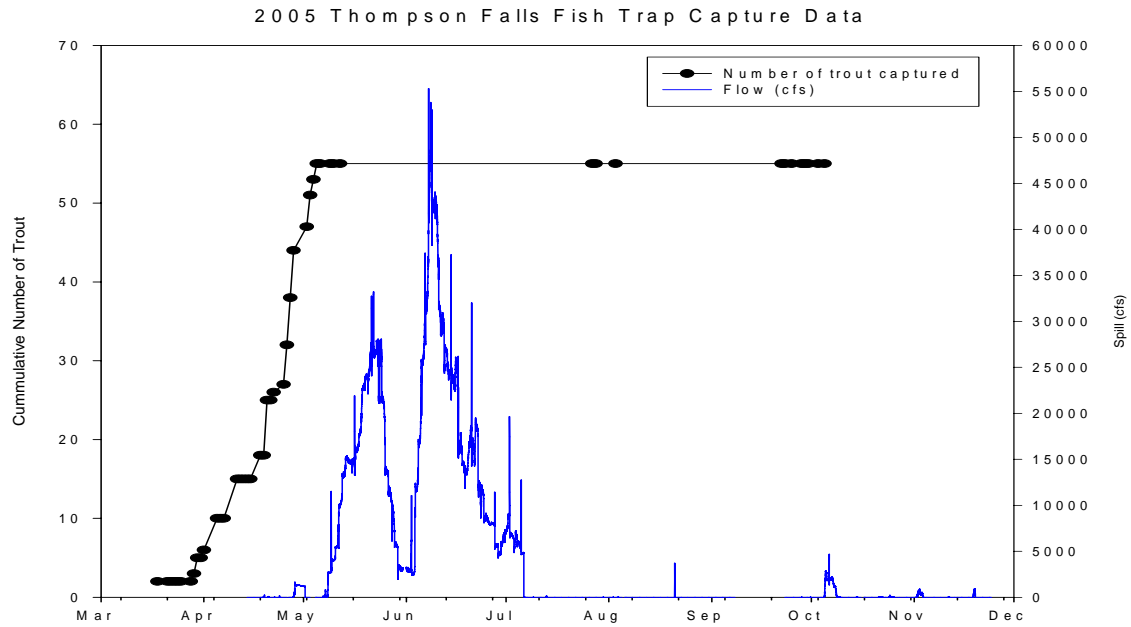

Figure 13 Cumulative number of combined trout (westslope cutthroat, rainbow, brown, and westslope cutthroat x rainbow trout hybrids) captured by date at the Thompson Falls Dam fish trap during 2006. Project spill, i.e. flow in excess of plant capacity which passed over the spillways, is indicated by the blue line and the right Y-axis

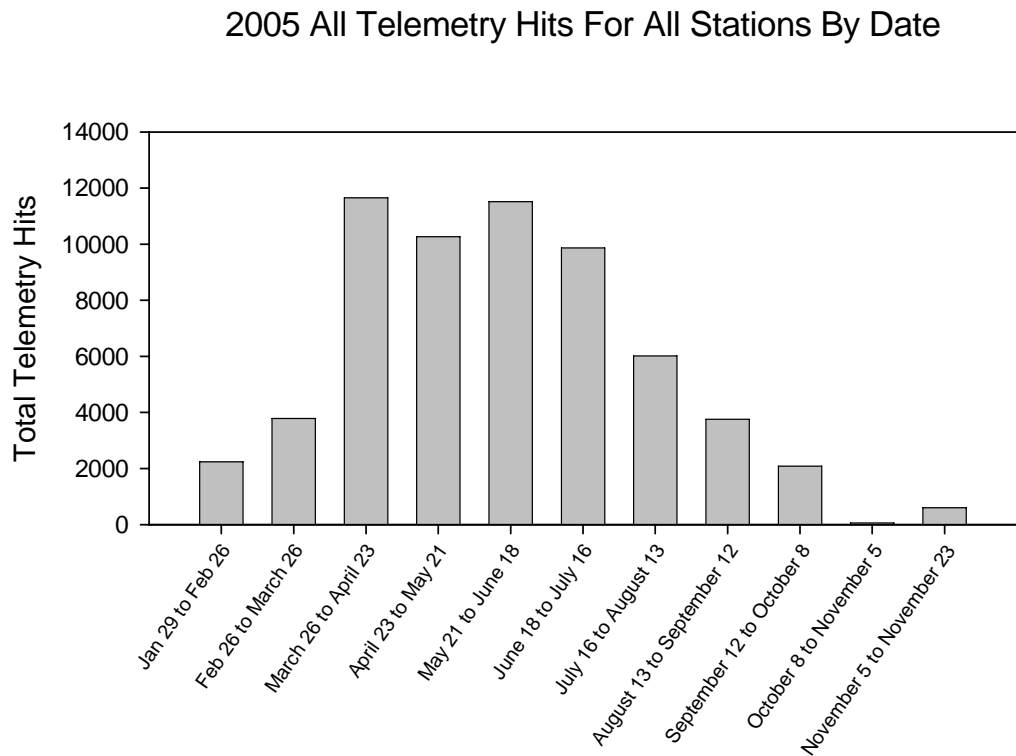

Figure 14 The total number of 15 minute time intervals when signals were recorded by the remote telemetry receivers at Thompson Falls Dam during 2005

The timing of movement of trout into the tailrace varies by species. Rainbow trout are the earliest fish to begin their upstream movements, followed by westslope cutthroat trout and then bull trout (Figure 15).

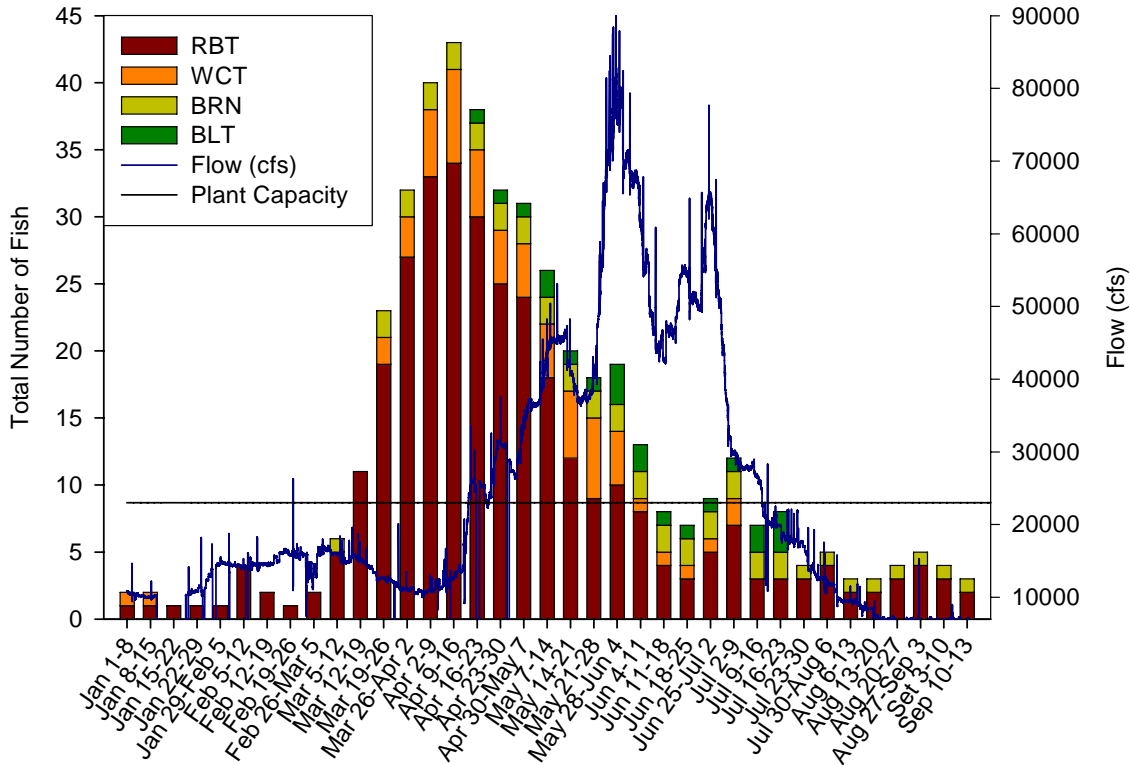

Figure 15 Total number of radio tagged fish, by species, detected in the Thompson Falls Dam tailrace during the first nine months of 2006

2.5.3 Tailrace Fish Behavior

Telemetry studies done from 2004 – 2006 indicate that a large proportion of fish that enter the Thompson Falls project area make their way to the area of the Main Channel Dam, which is the upstream most terminus a fish can currently navigate. The Main Channel Dam area attracts far more fish for longer periods of time that the old or new powerhouse areas. Although the hilltop receiver also detects a large number of fish, this station mostly detects fish later in the summer. We hypothesize that the generalized migration behavior is that trout initially migrate as far upstream as possible, to the Main Channel Dam. They later drop back to the area near the mouth of Prospect Creek during very high flow times and when water temperatures are warm.

During the 2006 study season we conducted experiments to determine if manipulating the spill operations at the main channel dam can stimulate the way fish behave in a manner that would optimize a fish passage facility's efficiency. In early spring, while river discharge was <23,000 cfs and no spill was occurring, we opened a half a panel on the Main Dam to see if we could draw additional fish to the Main Dam. We found that opening spillway panels prior to spill attracted fish to Main Dam. However, fish did not appear to move from left bank to right bank in response to opening one panel first on the left and then on the right.

During the 2005 study season, more fish were detected by the left bank antenna than the right bank antenna. We hypothesized that this was because hydraulic conditions were more suitable for fish on the left bank because of the order in which the panels were opened on the spillway. In 2006, once total discharge exceeded 23,000 cfs, we initiated a panel opening sequence designed to repel fish from the left bank and attract them to the right bank. We found that once spill began, the schedule of panel openings was successful in attracting fish to the right bank. Overall, fish do not remain static when they are in the Main Dam tailrace, they move around considerably from right to left bank.

3.0 Alternatives Development

3.1 Process Overview

The most important initial step in the design of upstream passage facilities for bull trout and other migratory non-anadromous fish was to identify fish behavior at the project site. Initial radio-telemetry studies commenced in 2004, and extended through 2006. Study plans were coordinated with resource agencies, and two primary potential sites for a future upstream fishway were selected. The site-selection process is vital in assuring that fish will approach and hold in the adjacent tailwater area. If this is not the case, building a fish ladder at that site would not pass fish. A draft site-selection letter report was prepared and reviewed at a January 27, 2006, meeting with the resource agencies. Their comments were integrated, and a final letter report, dated June 16, 2006, was prepared. It concluded (based on telemetry studies through 2005, and the 2006 telemetry studies results) that fish leave the higher powerhouse discharge and migrate to the upstream terminus (Main Dam spillway) during the height of their upstream migration surge (which begins in February-March and extends to near the peak of the spring freshet).

A tour of other fish passage and trapping facilities in the Columbia River basin occurred in April 2006, and was well attended by PPL and the resource agencies. This aided in increasing understanding about features under consideration for the new fishway at Thompson Falls.

The left and right abutments of the Main Dam were selected as sites to include in the upstream fishway feasibility study, and three alternatives were developed. Initial drawings and descriptions were circulated, then discussed at a June 22, 2006, meeting with the fish agencies. The comments received from that meeting were integrated into this draft feasibility study report, which will be distributed to the agencies in September 2006, and discussed at the scheduled October 5 on-site meeting.

3.1.1 Site Selection Process and Letter Report

PPL wisely selected radio-telemetry to identify behavior of bull trout at Thompson Falls. Understanding bull trout, and other migratory trout behavior is a pre-requisite for selecting the optimum upstream-passage fishway site. If the wrong site is selected, a costly fishway may pass few or no fish. The draft letter report (discussed with the agencies at the January 27, 2006, on-site meeting) was prepared on the basis of preliminary 2004 and 2005 telemetry data, and the recommended fishway location was the Main Dam spillway. This was based on telemetry showing that fish would leave higher powerhouse discharges (up to 23,000 cfs) and migrate upstream in a wide, deep pool (with only spillway leakage flow) to the upstream-most passable terminus of the river channel. The agencies requested that additional telemetry

data be reconciled, and that both left and right Main Dam spillway abutments be evaluated in the pending feasibility study. The final letter report, dated June 15, 2006, integrated the additional 2005 fish behavioral information requested by the agencies, recommended both the left and right Main Dam spillway abutments as sites to be evaluated for new fishways. Because of unique telemetry software, 2006 telemetry data was reconciled and available discussion at the June 22 meeting. For 2006, telemetry studies were to assess the newly developed Main Dam spill schedule (see Section 2.2 discussion of spillway operations), which was designed on the basis of the hypothesis that controlling the Main Dam spillway tailrace hydraulics would also influence tailrace fish behavior. The objective was to determine if tagged fish would avoid the left shoreline, due to excessive turbulence from prioritized open lift gates starting at Spill Bay 36. On the rising hydrograph, lift gates were opened primarily from left to right, on the premise that fish would avoid the turbulent left half of the spillway tailrace channel, and be attracted to the right abutment tailrace area. It was generally observed that tagged fish would approach and hold in the right abutment tailrace, even if they initially approached the Main Dam spillway along the left shore.

3.2 Design High and Low Project Discharges for Upstream Fishway

The new fishway, either at the left or right Main Dam spillway abutment, needs to be designed on the basis of a range of operational discharge which is determined in advance. This range of operational discharge will be translated into stage elevations which will be the range over which the fishway will operate. This range is an important consideration in fishway designs, and is based on site conditions, fish behavior, and the need to protect facilities during flooding. Tailwater rating curves must be developed initially to allow preliminary layouts, and are important in determining the total number of pools in a full-height fish ladder option.

At the Main Dam spillway, it is known from telemetry studies that fish can enter the immediate tailrace when there is leakage-only passing (across the entire dam width) into the tailrace. This constitutes the low design tailwater condition (see tailwater rating curve in Section 2.4).

- Right Abutment Low Design Tailwater El 2350
- Left Ladder Low Design Tailwater Elev. 2335.

The high design tailwater condition for the right bank is that tailwater elevation for which it may be possible to collect fish holding in the immediate spillway tailrace, even though spill continues to rise on the ascending hydrograph. It is assumed that these fish may not be able to ascend to the Main Dam, but are in the immediate tailrace after approaching at lower spills.

- Right Bank High Design Tailwater elevation is El 2359 (40,000 cfs spill).
- Left Bank High Design Tailwater is assumed to be El 2358.
- Right Abutment Flood Tailwater Elev (where walls become overtopped and could prevent damage to the fishway) is 2369.

3.3 Site Structural and Civil Engineering Considerations

The existing Main Dam facility at Thompson Falls consists of an arch shaped, concrete gravity structure. With the exception of the non-overflow and log sluice portions of the dam near the right abutment, the majority of the dam was designed as an ogee spillway with a crest approximately 18 feet above the river bed. The non-overflow section was also designed as a gravity structure. A log sluice was constructed between the non-overflow and ogee dam sections. The sluice facility is currently not being used and shows signs of deterioration including cracking and significant concrete spalling. At this time, GEI Consultants is not aware of any lateral reinforcement within the dam concrete. Core samples taken through the dam concrete during the 1993 Materials Testing Program did not encounter rebar. Rebar reinforcing was observed by GEI during a recent site visit within the log sluice. In later years, 189 kip rock anchors were installed near the upstream toe of the ogee dam sections to reduce the tensile forces at the upstream toe concrete/foundation rock contact.

3.3.1 Right Abutment

Construction of both the right abutment fish ladder and lift options will require removal of at least a portion of the existing concrete log sluice. A previous stability analyses presented in the 1996 Inspection of the Project Works prepared by Raytheon incorporated the log sluice structure in the analysis. The minimum factors of safety were 36.13 against sliding during the seismic loading condition and 1.44 against overturning for the flood loading condition. These loading conditions were both evaluated assuming removal of a portion of the log sluice structure near the downstream end. A total log sluice length of 50 feet was assumed for the final configuration. By inspection, the factors of safety will exceed those computed for the ogee crest section in the adjacent panels 1 through 19 for both overturning and sliding. Although the dam is classified as a gravity structure, it is also not understood if any lateral loading is transferred along the centerline axis of the dam to the abutments due to the arch shaped configuration of the structure. Any penetrations through the non-overflow section should be analyzed using finite analysis methods to determine the magnitude of concentrated loads caused by such a penetration.

3.4 Other Design Considerations

Construction will be limited to periods of no spill over the Main Dam. The contractor will be required to construct cofferdams to protect the work and construction equipment. Earthen cofferdams would require removal at the end of each construction season to prevent additional sediment loading of the Clark Fork River.

A bridge was constructed in 1911 for access to the Dry Channel Dam construction which was completed in 1915. The Gallatin Street Bridge links the mainland to the island's north shore which separates the Main and Dry Channel dams. The condition of the bridge has deteriorated over the years therefore its load capacity is being questioned. DJ&A, P.C. was hired in July 2005 to assess the bridge and recommend repairs to bring the bridge back to its original capabilities. An inspection of the structure revealed 15 broken stringers in the three truss spans and approximately 35 deck planks rotten and in need of replacement. Due to these observations and various other issues, they recommended a reduced load capacity from original design until repairs could be done. The bridge can safely carry a ½ ton pickup truck (4000 lb. max. axle load). This load capacity will not allow the heavy construction equipment access to the right abutment via the bridge.

Repairs to the Gallatin Street Bridge should be included in the 2007 PPL Montana budget but this is not solidified as of September of 2006. DJ&A's recommended repairs to the bridge, if performed, would increase the load capacity to 11.8 tons for a type 3 truck (8,000 lbs. max. axle weight). The type 3 rating truck represents a three axle vehicle with the two rear axles spaced 4 feet apart and the distance from the front axle to the first rear axle equal to fifteen feet. A typical concrete truck fully loaded weighs about 40 tons, therefore, would not be able to cross the repaired bridge safely. A 14 ton capacity boom crane weighs approximately 11 tons riding on two axles. This too could not cross the bridge due to the number of axles. Therefore, even with the removal of the current load restrictions, we anticipate that construction equipment and materials concrete will have to be transported to the right abutment using unconventional methods.

Two alternatives under consideration would be utilizing a barge to transport concrete trucks and equipment across the forebay or utilizing the Main Dam rail system, with minor modifications to shuttle concrete across the dam.

All fish passage alternatives require excavation of the hard argillite bedrock up to 30 feet in depth. Due to the proximity of the dam structure, excavation by rock blasting adjacent to the dam should not be allowed. Line drilling and chipping of the bedrock is recommended near the dam. For the right abutment full height ladder alternative, we estimate a total excavation volume of 800 to 1,000 cubic yards of rock. This volume equals up to 2,300 tons of material which much be removed from the site or disposed of on-site. Since the existing Gallatin

Street bridge does not have the capacity for hauls of this volume, on-site disposal would be the recommended means of excess material handling.

3.4.1 Ladder Design

Swimming speed studies for bull trout were initiated by the USGS in 2003. Matt Mesa, the principle investigator, has been having difficulties holding the study animal, but so far he has observed relatively poor swimming performance. He concluded from his observations of bull trout swimming performance that ladder designs for non-anadromous species should include less strenuous hydraulic conditions. Thus initial planning for the Thompson Falls fishway included a half-Ice Harbor type ladder sized for a 0.75 ft drop from pool to pool.

While at Roza Dam with PPL and resource agency representatives, we observed a notched weir fishway, with 1-ft drop per pool. We observed the trapping and processing of fish, and noted the presence of many weaker-swimming species, including suckers. Mark Johnston at Roza Dam has confirmed that they catch a couple bull trout a year at the Roza trap, indicating that the 1-foot drop and Roza style ladder can successfully pass bull trout. Conversations between PPL Montana, the Montana regulatory agencies, and the Yakima Tribes lead biologist regarding a 0.75 ft vs 1-ft drop led to the unanimous choice of a 1-ft drop for the Thompson Falls fishway design.

While this seems risky, relative to feedback from USGS, we suspect that bull trout performance in the field is much stronger than that observed in the lab, where bull trout appeared to respond poorly to stress.

With the half Ice Harbor design, increasing the drop from 0.75-foot to 1-foot led to increases in pool volume and length to accommodate the additional energy to be dissipated. It became apparent that changing the length and width (even by a foot) meant there was a completely different pool layout. Further, there was not enough room for the needed 48- 5' x 7' pools. It became apparent that we needed to assess different weir types, and pool volumes - relative to the energy dissipation factor, defined as the pool discharge x pool drop x specific gravity of water divided by submerged pool volume. For salmon (stronger swimmers) the limiting empirical value is 4.0. For bull trout, we believe 3.5 would be a good EDF coefficient.

Thus, the half Ice Harbor design was changed to the Roza design. At Roza, the notched weir width is approximately 2-ft, and discharge is 6-7 cfs. One advantage is that flow is not split, as with an orifice/weir. Thus the Roza design doesn't require as much flow as other designs, and therefore allows less volume per pool.

The final pool size selected for the ***right bank full height ladder*** option and for the ***updated left bank ladder layout*** is: 6-ft long x 5-ft wide x 4-ft deep, which gives an EDF = 3.38.

4.0 Description of Alternatives

4.1 Alternative #1, Right Full-Height Ladder

4.1.1 Functional Description

This alternative is a pool and weir type fish ladder (Figures A.3 and A.4), and includes notched weirs between each successive ladder pool, similar to Roza Dam. Approximately 6 cfs will pass through a trash rack, and into a 3 ft diameter tunnel that will be bored through the existing non-overflow wall of the Main Dam. Flow will pass from pool to pool through a 2 ft wide notch, and energy from inflow to each pool will be dissipated before passing to the next pool. Turbulence in each pool will be at a moderate level, but will allow enough fish holding space that weaker swimming species should have no problem ascending the ladder. A 4-inch orifice is located at the invert elevation of each weir, which allows the ladder to be dewatered. Representatives from the regulatory agencies agreed (on the April 22, 2006, Roza Dam site visit) that the Roza-type ladder would be satisfactory for Thompson Falls alternatives.

An auxiliary water system (AWS) will add diffused flow into the downstream-most ladder pool(s), and combine with the 6 cfs ladder flow to create attraction discharges from the lowest fish ladder pool (the “entrance pool”) into the tailrace. Total discharge from the entrance pool will be up to 60 cfs. The AWS diffused flow (54 cfs) to be added from the AWS will pass through a diffuser barrier with small openings, so that fish are not able to pass into the AWS system. In the forebay, AWS flow will pass through a vertical traveling screen, which will be installed at the upstream nose of the two piers at the existing sluiceway entrance. (The existing sluiceway has not operated for years.) The purpose of this screen is to collect debris that would otherwise pass into the AWS, and remove it so that it does not clog the add-in diffuser at the entrance pool. An AWS flow-control gate will be immediately downstream of the intake traveling screen, and will be designed to pass 54 cfs. A porosity plate will be placed immediately downstream of the traveling screen to induce uniform flow through the screen. Energy dissipation (either by stilling pool, baffled chute in the existing sluiceway, or a combination of both) will occur before AWS flow enters the entrance pool. A second AWS feature is an 18-in diameter high-velocity attraction jet that will discharge directly into the tailrace, adjacent to the fish ladder entrance. This feature will aid in attracting fish to the ladder entrance. Flow-control will be at a gate immediately downstream of the intake traveling screen, and a vented pipeline will convey flow to the discharge point.

Fish passing this ladder will be able to pass directly into the forebay. This option does not include a truck-loading capability.

4.1.2 Hydraulic Considerations

Forebay elevation is maintained at 2396 cfs during non-spill periods. However, the pool may be as high as el. 2397 during spill. Hydraulic drop at the fishway entrance will be up to 1-ft, and is determined by the amount of AWS flow added to the 6 cfs ladder flow in the entrance pool. The ladder entrance is to be 3-ft wide and 4-ft high. If the entrance hydraulic drop and velocity (8 fps) is excessive for some species, a lower entrance attraction velocity can be selected by reducing AWS flow added to the entrance pool. However, this reduces the distance into tailwater that the entrance attraction jet will extend (meaning fish will have to pass nearer the ladder entrance to perceive its presence). For this reason, the design includes a high-velocity attraction jet adjacent to the ladder entrance. Fish attracted to the high-velocity jet will not be able to pass the jet, but will be attracted by it and may more easily detect and enter the ladder entrance with the high-velocity jet operating.

Static head (from forebay to tailwater) is approximately 48 ft at low tailwater, which suggests that 48 pools are required if the pool-to-pool drop is 1-ft. As tailwater rises, the lower ladder weirs are submerged. There are AWS add-in diffusers at pools 3, 5, and 7, in addition to the entrance pool. As tailwater rises to the elevation of the high design flow (spill = 40,000 cfs and TW = 2359), some auxiliary water is being added through diffusers at upstream pools, in order to maintain adequate transport velocity over submerged weirs. This creates a perceptible velocity over submerged weirs to attract fish further up the ladder, to weirs that are not submerged.

The upper three pools of the ladder have 12-in wide x 14-in high orifices, rather than notches. These will each be designed for a 1-ft drop at normal forebay (el. 2396). However, since the forebay is purposely held up to 1 foot higher during spill, orifices will dampen the increase in ladder flow. A screened overflow (with backset weir) will also aid in controlling the water level (and therefore ladder flow) in pool 45, for both sampling and non-sampling operations.

At the mean annual maximum flood discharge, spill is great enough that high tailwater exceeds the high design discharge (flood spill = 80,000 cfs and TW = 2368), and top-of-wall elevations for the lower ladder pools need to be above that level to avoid flooding adjacent to the lower ladder.

4.1.3 Fish Sampling

Fish ascending the ladder will be passed either directly to the Main Dam forebay, or routed into a sample loop adjacent to the upper-most fish ladder pools. If the desire is to route fish into the sample loop, a vee-trap (or finger weir) will be opened to allow fish to enter a holding pool. Concurrently, a diffuser leading to the next ladder pool will be closed and a gate will be opened to route flow to the holding pool. Fish entering the holding pool can then be crowded to one end, and routed to a chute with a diverter gate. Fish can then be routed

back to tailwater, to forebay, or into an anesthetic tank. Other options are also available, but the details of the final sampling needs have not been determined. A small pump may be required for sampling water supply needs.

4.1.4 Constructability Issues

Heavy construction equipment (cranes, concrete trucks, etc) will need to access the site through means other than the Gallatin Street bridge. Barges or other options may have to be used.

The site topography and bathymetry are characterized by jagged rock outcrops. Construction for this ladder will be in a relatively small triangular footprint, which is bordered by the non-overflow section of the Main Dam, the vertical bedrock face, and the abandoned sluiceway. A cofferdam will be required to remove some or all of the downstream end of the sluiceway and construct the ladder entrance pool (the slab of which will be 4-ft below low tailwater), but the dewatered foot print will be relatively small. Cofferdam work will be during a non-spill period, but will have to be placed on bedrock. Rock excavation volume is a relatively small quantity at this site. Equipment access will need to be lifted into the construction footprint by a crane, expected to be barge-mounted and secured to the upstream face of the Main Dam structure. Foot access within the triangular ladder footprint is not expected to be prohibitive, but surfaces will be sloped, possibly wet, and safety will be a concern. All heavy equipment and materials are expected to be barge-delivered.

The downstream portion of the sluiceway will need to be removed to make way for the lower ladder pools, and to allow for the AWS stilling pools and baffles.

4.1.5 Operations and Maintenance

The full-height ladder will have a traveling screen and AWS diffusers at the entrance pool, and pools 3, 5, and 7. The traveling screen will need to be kept in working order. The screen will need to be kept free of debris, along with the ladder exit trash rack. A trough can be designed to route debris laterally from the traveling screen to an appropriate debris release location. The exit trash rack passes small enough discharge that it will not require frequent manual cleaning (raking). As spill drops to zero in June or July, either leakage (100-200 cfs) or a dedicated adjacent spillway lift gate may need to be opened incrementally to allow fish to be attracted to the right bank fishway. Overall, there is expected to be a relatively small operations and maintenance requirement, based on few moving parts.

4.1.6 Advantages of the Right Ladder Alternative:

- Passive passage conditions – fish can enter and pass the full ladder volitionally
- Triangular footprint for ladder is small, but adequate

- Non-overflow wall protects construction site
- Limited upstream construction need (tunneling)
- Space available for fish sampling facilities
- Limited imported fill placement/removal
- Tailrace cofferdam will be small
- Only a small amount of rock excavation
- Relatively low operations and maintenance requirements
- Construction upstream of the dam is limited to tunneling, traveling screen installation, and trash rack placement. Some of these features may be prefabricated to allow limited forebay drawdown (foregone power) period.

4.1.7 *Disadvantages of the Right Ladder Alternative*

- Poor access for heavy loads, due to Gallatin bridge limitation
- Will need small circular tunnel through non-overflow section of dam
- Need to remove downstream portion of the sluiceway structure.
- May be a significant predation problem at the fish ladder exit
- Fish passing during spill may be swept back over the dam by strong forebay spill lift gate flow-fields
- Greater cost than trap and haul option
- Limited operational flexibility to route fish elsewhere if there is a predation problem at the ladder exit

4.2 Alternative #2, Fish Lock

4.2.1 *Functional Description*

This alternative is similar to Alternative 1, but the ladder pools do not extend full-height. Instead, it has the same lower ladder and AWS facilities, which extend to just above the design high tailwater elevation (Figure A.5). The middle and upper ladder pools are replaced by a holding pool and lock, which allow fish to be trapped, crowded into the lock, then locked to the forebay level (or above). As fish enter the holding pool, they pass through (or over) a finger weir, vee-trap, or some other trapping device designed to disallow fish fall-back to lower pools. At appropriate locking intervals, a crowder can be lowered into the holding pool, and fish can be crowded into the lock. The lock closure gate is then lowered, and the lock pump started. Pumped flow is introduced below a lowered floor Braille in the lock. As the lock water level rises, the floor Braille can be lifted to crowd fish upward. At the top of the lock, rising water starts to overflow into a chute (with floor screen and drain valve to control residual water flow down the chute). Diverter gates can be remotely opened to route fish to the forebay, onto a rail-mounted fish tank (for subsequent loading onto a truck trailer at a left bank loading station), back to tailwater, or into sample facilities. Figure A.6

shows the working deck near the top of the lock. It will tentatively allow sampling facilities placement and ample working space. This deck will be at an elevation high enough to allow distribution flumes to load the rail-mounted fish tank (referenced above). It is anticipated that fish tank capacity will be approximate 500 gallon (dependent on criteria to be developed in conjunction with the resource agencies).

4.2.2 Fish Transport System

A rail system exists on the Thompson Falls Main Dam which covers the entire length of the dam. The main purpose of the rail system is to allow two rail mounted cranes free access along the deck for panel removal/insertion, debris removal, and maintenance of the dam. Two storage sheds, one at each end of the dam, house the cranes when not in use.

For this alternative, the rail system could be shared by both biologists and the dam operators. A fish transport tank (similar to Figure 16) could be mounted on a properly designed rail



Figure 16 Example fish transport tank

cart that would roll up to the proposed fish sampling station for loading via an open trough or flexible tube. The fish payload then could be driven across the dam to the left bank where a transfer station would be designed to facilitate fish tank transfer to a trailer. The tank then could be hauled to the desired release point via a standard truck.

Modifications to the existing rail system would be minor and address both fish tank transfer and operator needs. The right bank crane storage shed would have to be modified for fish tank access to the fish ladder/lock system. When not in use, the fish tank cart could be stored in the right side storage shed, protected from the elements and out of the path of dam operators. The maximum lift needed for flume transfer of fish to the tank would be addressed in the design phase of the lock/ladder component.

This concept has been coordinated with the chief dam operations supervisor, who has shown interest in having both cranes stored in a new left bank shed which would house both cranes. The left bank would have a total of three parallel rails that would terminate in the area, all joined to the main rail with railroad switches similar to Figure 17. Each crane would have its own rail for storage (preferably under the same roof) and the third would be used by the fish tank cart for transfer to a trailer. The cart would enter a transfer station where the tank would be loaded onto a flatbed trailer. A system would be devised to slide or roll the tank onto the trailer without the need for overhead craning or heavy machinery.

This route of fish transport would utilize pre-existing infrastructure and reduce the overall cost. This approach would also address operator requests for an improved maintenance shed which would be able to house both cranes for maintenance and upkeep.



Figure 17 Example rail line with switches

4.2.3 Hydraulic Considerations

Lower ladder hydraulic facilities are similar to Alternative 1. The AWS remains essentially unchanged. This option has separate pump requirements for filling the lock and sampling needs, which will be laid out during the next design phase.

4.2.4 Fish Sampling

Fish can be routed directly to forebay, onto a portable fish tank, back to tailwater, or into sample facilities. Figure A.6 shows the tentative layout of a working deck near the top of the lock. It should allow sampling facilities placement flexibility and ample working space. Access to this deck will be by personnel stairway from the existing forebay deck to both the lower ladder, and to the elevated sampling deck.

4.2.5 Constructability Issues

Heavy construction equipment (cranes, concrete trucks, etc) will still need to access the site through barges.

The site topography and bathymetry are characterized by jagged rock outcrops. Construction for this ladder/lock composite will be in a relatively small triangular footprint, which is bordered by the non-overflow section of the Main Dam, the vertical bedrock face, and the abandoned sluiceway. A cofferdam will be required for removal of some, or all, of the downstream portion of the sluiceway and construction of the ladder entrance pool (the slab of which will be 4-ft below low tailwater), but the dewatered foot print will be relatively small. Cofferdam work will be during a non-spill period, but will have to be placed on bedrock. Bedrock excavation volume is a relatively small quantity at this site. Equipment access will need to be lifted into the construction footprint by a crane, expected to be barge-mounted and secured to the upstream face of the Main Dam structure. Foot access within the triangular ladder footprint is not expected to be prohibitive, but surfaces will be sloped, possibly wet, and safety will be a concern. All heavy equipment and materials are expected to be barge-delivered.

The downstream portion of the sluiceway will need to be removed to make way for a new exterior wall (adjacent to, and extending downstream of, the spillway apron) for the lower ladder pools, and to enclose the AWS stilling pools and baffles.

4.2.6 Operations and Maintenance

Operations requirements will be greater with this option, as dedicated staff will need to operate both the lock and truck-trailer units. It is uncertain how often the lock will have to be operated; however, one lockage per day minimum is expected during months when upstream

migrating fish are present (February through May). Frequency of locking need will be based on experience. During the peak upstream migration, multiple lockages per day may be required to minimize fish holding time in the holding pool. As spill drops to zero, either leakage (100-200 cfs), or dedicated adjacent spillway lift gate (partially-opened) operation may be required to create attraction flow to induce fish approach and entrance into the right bank fishway.

4.2.7 Advantages of the Fish Lock Alternative

- Greatest operating flexibility: can route fish to forebay, or load fish in the above-referenced tank for transport to a safe upstream fish release location.
- Small, but adequate, footprint for the lock
- Non-overflow wall protects construction site
- Limited imported fill placement/removal
- Elevated space (above high design tailwater) for sampling facilities
- Can use existing rail system for easy loading of portable fish tank on left bank
- Tailrace cofferdam will be relatively small
- Only a small amount of rock excavation
- Will not need tunnel through non-overflow section of dam
- Safer fish passage during spill, since hauling by truck may preclude fish being swept back over the dam by strong forebay spill lift gate flow-fields
- Least forebay dewatering and construction requirement of the three options (meaning lowest time required for construction-related lowering of forebay pool)
- Lower construction cost

4.2.8 Disadvantages of the Fish Lock Alternative

- Lack of passive passage conditions – fish cannot enter and pass the full height of the ladder volitionally, but are passed on the basis of fish holding time limitations and labor considerations
- Relatively high, longer-term operator and equipment (ladder, lock, sampling facilities, transport tank, trailer, and truck requirements) costs
- Relatively high maintenance requirements, due to more moving parts, pumps and other mechanical features
- Poor access for heavy loads, due to Gallatin bridge limitation
- Need to remove downstream portion of the sluiceway structure.

4.3 Alternative #3, Left Full-Height Ladder

4.3.1 Functional Description

The Main Dam left abutment full-height fish ladder option, as shown in Figures A.7 and A.8, has a long, relatively flat, section across the current vehicle-access and parking area, connected to a steeper zone that drops to the river. A trapezoidal channel would be excavated for both the flat and steep gradient portions of the ladder, with excavated rock serving as one of the sidewalls (instead of concrete). The entire ladder would need to be fenced, to negate public access. The upstream end of the ladder would pass under the rail tracks. In the steeper gradient zone, Roza-type notched-weir ladder pools (of the same approximate size as the right abutment ladder alternative) would pass 6 cfs from pool to pool. A 4-inch orifice is located at the invert elevation of each weir, which allows the ladder to be dewatered. A junction pool routes flow to one of two laterals to accommodate both spill and non-spill operations. Both laterals lead to entrances on the downstream side of the abrupt shoreline bend, which is located a few hundred feet downstream of the Main Dam spillway left abutment. The reason for these ladder entrance locations is that the steep gradient along the left shoreline is a barrier to fish during spill.

The *spill operations lateral* entrance pool discharges into a tailwater pool (immediately downstream of the left shoreline bend) that is the upstream terminus for migrating fish approaching the Main Dam spillway along the left shoreline during spill. The *non-spill operations lateral* entrance pool discharges into the large backwatered pool that extends upstream from the two powerhouses.

Auxiliary water for this alternative would be a gated 18-in diameter high-velocity attraction jet that discharges directly into the tailrace, adjacent to the fish ladder lateral entrances to aid in attracting fish. This would allow discharge of up to 30-40 cfs, and a velocity of over 20 fps. Neither of these laterals discharge in the immediate tailrace pool below the Main Dam spillway apron. Fish passing this ladder will be able to pass directly into the forebay.

An important limitation of the revised left ladder is that it is not currently a good non-spill (nor low-spill) fish holding area, due to leakage at the Main Dam. Leakage from lift gates (which can be up to approximately 200 cfs) attracts fish to the immediate tailwater below the spillway apron. Low-spill discharges are expected to do the same. Attraction to the spillway could be negated during non-spill if the leakage were to be stopped by modifying lift panels and stoplogs at the dam. This is a task that PPL says would cost approximately \$1 million, and is scheduled for the next 15 years or so. If spillway leakage is stopped, an adjustable discharge attraction jet would need to be released adjacent to the non-spill lateral entrance, to attract fish to this flow source. Even if leakage at the dam is negated, there are still occasions during the start of spill when low-level spill discharge will attract fish to the spillway –

upstream of the two left ladder entrances. Once fish are upstream of the two entrances, they will not drop back downstream, and it is doubtful they will pass the dam.

Figure 11 shows the extent of rise in tailwater at higher total project discharges. Due to the extent of tailwater rise at typical spring annual spring freshet discharges, the non-spill lateral will be under water for days or weeks at a time. Therefore, high spring flows will create high structural and functional risks.

4.3.2 Hydraulic Considerations

The long, flat-gradient portion of the ladder passes only 6 cfs, but transport velocity must be great enough to induce fish to continue moving upstream. A minimum transport velocity is attained in this design by placing weirs with larger notches every 30 ft, thereby inducing a drop of a few-tenths of a foot at each weir (and a 3-4 fps velocity). This induced jet will dissipate between weirs, but should be sufficient to keep fish moving upstream in this section. Measures to modulate the forebay elevation changes (from normal forebay elevation of 2396, to a maximum el. 2397) are required, but not shown at this design stage.

4.3.3 Fish Sampling

Sampling capabilities at the left ladder exit can be included in design, but are not shown at this design development stage.

4.3.4 Constructability Issues

The site topography for this ladder option is characterized by bedrock and jagged rock outcrops. Rock excavation yardage is appreciable, although road access to the left bank is good. Access for excavation in the steeper downstream ladder zone is not good, and is poorer yet at the downstream laterals. Cofferdams would be needed for construction of the non-spill entrance.

4.3.5 Advantages of Left Ladder Alternative

- Good road access to the upper ladder area
- Some savings by using excavated rock wall as a fishway wall
- Passive fish passage
- During spill > 20 kcfs, has best apparent entrance location for fish

4.3.6 Disadvantages of Left Ladder Alternative

- Extensive rock excavation
- Rugged topography in the lower ladder footprint creates accessibility problems
- Fish passing to the dam during low or non-spill (leakage-only) periods would probably not fall back and find the ladder entrances.
- Lower ladder non-spill lateral and entrance would be submerged at typical peak spring total project discharges, providing exposure to structural damage from coarse debris
- This option tries to fool fish by attracting them to downstream spill and non-spill entrances, and is dependent on stopping stoplog and lift gate leakage at the Main Dam
- The prime holding water near the ladder entrance (around shoreline bend) only occurs at > 20 kcfs spill (while most fish expected to pass at zero or low spill)
- Potential predation and fallback at exit
- Large ladder footprint
- Limited space for sampling facilities without appreciable rock excavation
- Rugged bathymetry in ladder footprint
- Greater expected maintenance and repair needs

4.4 Alternative Cost Estimates

Cost estimates should be considered DRAFT. They are under further review within GEI. Cost estimates include engineering and construction, but not permitting. Operations and maintenance costs are in preparation and will be available prior to the Interagency Technical Committee meeting October 5.

**Thompson Falls Upstream Fish Passage
Alternative 1 - Right Abutment Full Height Ladder**

Description	Quantity	Unit	Unit Price	Total Cost
Rock Excavation, Controlled Blasting	815	BCY	\$180	\$146,700
Concrete Demolition	550	CY	\$100	\$55,000
Fish Ladder, Concrete	440	CY	\$1,200	\$528,000
Fish Ladder, Structural Members	1	LS	\$360,000	\$360,000
Dental Concrete	10	CY	\$300	\$3,000
Rock Bolts	1	LS	\$100,000	\$100,000
Fish Transport Improvements	1	LS	\$150,000	\$150,000
Stairs and Manway Access	1	LS	\$238,290	\$238,290
Valves, Gates, and Piping	1	LS	\$208,250	\$208,250
Sampling Station	1	LS	\$31,125	\$31,125
Lock House	1	LS	\$67,500	\$67,500
Fish Lock - Structural	1	LS	\$93,125.00	\$93,125
Fish Lock - Mechanical	1	LS	\$49,805.00	\$49,805
Electrical	1	LS	\$145,500.00	\$145,500
Dewatering/Cofferdam	1	LS	\$50,000	\$50,000
Barge Mobilization, Assembly, Breakdown	3	EA	35,000	\$105,000
Barge Rental	190	Day	2,000	\$380,000
Crane Mobilization (75 ton assumed)	2	EA	12,000	\$24,000
Crane Rental	265	Days	500	\$132,500
			Subtotal	\$2,867,795
Unitemized Work and Materials at 15% of Subtotal				\$430,169
Base Construction Subtotal (BCS)				
				\$3,300,000
Mobilization and Demobilization at 10% of BCS	1	LS	\$330,000	\$330,000
Bonds and Insurance at 4% of BCS	1	LS	\$131,919	\$132,000
Direct Construction Subtotal (DCS)				
				\$3,762,000
Construction Contingencies Allowance at 10% of DCS	1	LS	\$376,200	\$376,200
Final Design Allowance at 10% of DCS	1	LS	\$376,200	\$376,200
Construction Management Allowance at 10% of DCS	1	LS	\$376,200	\$376,200
Project Subtotal				
				\$4,890,000
Project Contingency at 10% of Project Subtotal	1	LS	\$489,000	\$489,000
Draft Opinion of Probable Project Cost, September 2006				\$5,380,000

**Thompson Falls Upstream Fish Passage
Alternative 2 - Right Abutment Fish Lift**

Description	Quantity	Unit	Unit Price	Total Cost
Rock Excavation, Controlled Blasting	690	BCY	\$180	\$124,200
Concrete Demolition	550	CY	\$100	\$55,000
Fish Ladder, Concrete	155	CY	\$1,200	\$186,000
Dental Concrete	10	CY	\$300	\$3,000
Rock Bolts	1	LS	\$100,000	\$100,000
Fish Transport Improvements	1	LS	\$150,000	\$150,000
Stairs and Manway Access	1	LF	\$238,290	\$238,290
Valves, Gates, and Piping	1	LS	\$446,250	\$446,250
Sampling Station	1	LS	\$31,125	\$31,125
Lock House	1	LS	\$67,500	\$67,500
Fish Lock - Structural	1	LS	\$372,500	\$372,500
Fish Lock - Mechanical	1	LS	\$80,220	\$80,220
Electrical	1	LS	\$145,500	\$145,500
Barge Mobilization, Assembly, Breakdown	3	EA	\$35,000	\$105,000
Barge Rental	190	Day	\$2,000	\$380,000
Crane Mobilization (75 ton assumed)	2	EA	\$12,000	\$24,000
Crane Rental	210	Days	\$500	\$105,000
Rock driller/blaster mobilization/explosives storage	1	Ea	\$35,000	\$35,000
Dewatering/Cofferdam	1	LS	\$50,000	\$50,000
			Subtotal	\$2,698,585
Unitemized Work and Materials at 15% of Subtotal				\$539,717
Base Construction Subtotal (BCS)				
				\$3,240,000
Mobilization and Demobilization at 10% of BCS	1	LS	\$323,830	\$324,000
Bonds and Insurance at 4% of BCS	1	LS	\$129,532	\$130,000
Direct Construction Subtotal (DCS)				
				\$3,694,000
Construction Contingencies Allowance at 10% of DCS	1	LS	\$369,400	\$369,400
Final Design Allowance at 10% of DCS	1	LS	\$369,400	\$369,400
Construction Management Allowance at 10% of DCS	1	LS	\$369,400	\$369,400
Project Subtotal				
				\$4,800,000
Project Contingency at 10% of Project Subtotal	1	LS	\$480,000	\$480,000
Draft Opinion of Probable Project Cost, September 2006				\$5,280,000

**Thompson Falls Upstream Fish Passage
Alternative 3 - Left Abutment Full Height Ladder**

Description	Quantity	Unit	Unit Price	Total Cost
Rock Excavation, Controlled Blasting	2200	BCY	\$110	\$242,000
Concrete Demolition	25	CY	\$150	\$3,750
Fish Ladder, Reinforced Concrete	750	CY	\$1,200	\$900,000
Fish Ladder, Mass Concrete	180	CY	\$400	\$72,000
Fish Transport Improvements	1	LS	\$50,000	\$50,000
Dental Concrete	40	CY	\$300	\$12,000
Rock Bolts	1	LS	\$100,000	\$100,000
AWS Attraction Pipe	670	LF	\$100	\$67,000
Sampling Facilities	1	LS	\$31,125	\$31,125
Stairs and Manway Access	1	LS	\$238,290	\$238,290
Valves, Gates, and Piping	1	LS	\$378,875	\$378,875
Sampling Station	1	LS	\$31,125	\$31,125
Lock House	1	LS	\$67,500	\$67,500
Fish Lock - Structural	1	LS	\$93,125	\$93,125
Fish Lock - Mechanical	1	LS	\$49,805	\$49,805
Electrical	1	LS	\$145,500	\$145,500
Crane Mobilization (75 ton assumed)	2	EA	\$12,000	\$24,000
Crane Rental	160	Days	\$500	\$80,000
Rock driller/blaster mobilization/explosives storage	1	Ea	\$35,000	\$35,000
Dewatering/Cofferdam	1	LS	\$50,000	\$50,000
Chain Link Fencing	800	LF	\$30	\$24,000
			Subtotal	\$2,695,095
Unitemized Work and Materials at 15% of Subtotal				\$539,019
Base Construction Subtotal (BCS)				\$3,234,000
Mobilization and Demobilization at 10% of BCS	1	LS	\$323,400	\$323,400
Bonds and Insurance at 4% of BCS	1	LS	\$129,360	\$129,360
Direct Construction Subtotal (DCS)				\$3,687,000
Construction Contingencies Allowance at 10% of DCS	1	LS	\$368,700	\$368,700
Final Design Allowance at 10% of DCS	1	LS	\$368,700	\$368,700
Construction Management Allowance at 10% of DCS	1	LS	\$368,700	\$368,700
Project Subtotal				\$4,793,000
Project Contingency at 10% of Project Subtotal	1	LS	\$479,300	\$479,300
Draft Opinion of Probable Project Cost, September 2006				\$5,272,000

5.0 Conclusions

This report was prepared in draft and submitted to the Thompson Falls Fish Passage Interagency Working Group. The Interagency Group met October 5, 2006, in Thompson Falls to discuss the results of the radio telemetry study and the draft feasibility study. The goal for the meeting was to select one of the three fishway alternatives as a preferred alternative so that we can go forward with design.

Persons attending the meeting were:

NAME	COMPANY	EMAIL ADDRESS	TELEPHONE
Steve Rainey	GEI Consultants, Inc.	srainey@geiconsultants.com	503-697-1478
Brent Mabbott	PPL Montana	lbmabbott@pplweb.com	406-533-3447
Brad Liermann	Montana Fish, Wildlife and Parks (MFWP)	bliermann@blackfoot.net	406-827-9282
Ladd Knotek	MFWP	lknotek@mt.gov	406-542-5506
Jay Stuckey	MFWP	jstuckey@blackfoot.net	406-827-9205
Joe DosSantos	Avista Corp.	Joe.Dossantos@avistacorp.com	406-847-1284
LaDana Hintz	Avista Corp.	LaDana.Hintz@avistacorp.com	406-847-1294
Frank Pickett	PPL Montana	fpickett@pplweb.com	406-533-3445
Doug Foss	GEI Consultants, Inc.	dfoss@geiconsultants.com	406-522-9669
Ginger Gillin	GEI Consultants, Inc.	ggillin@geiconsultants.com	406-829-3648
Chad Masching	GEI Consultants, Inc.	cmasching@geiconsultants.com	303-662-0100
Joseph McKerley	MFWP		406-827-9205
Wade Fredenberg	U.S. Fish and Wildlife Service	wade_fredenberg@fws.gov	406-758-6872
Sam Milodragovich	Northwestern Energy	Sam.Milodragovich@northwestern.com	406-497-3102
Rich Parker	GEI Consultants, Inc.	rparker@geiconsultants.com	406-522-9680
Bill Beckman	PPL Montana	wobeckman@pplweb.com	406-533-3180
Jon Jourdonnais	PPL Montana	jhjourdonnais@pplweb.com	406-533-3443
Carrie Harris	PPL Montana	caharris@pplweb.com	406-533-3429

5.1 Summary of Discussions

The group heard presentations about the fishway feasibility report, and visited the project site. The group reconvened after the site visit to discuss a decision about the preferred alternative for the fishway. Wade Fredenberg, the USFWS representative, stated that we should abandon the left bank fishway alternative because it is too risky. Brad Liermann, one of the MFWP representatives, felt that the left bank alternative would not be effective at all different flow levels. The MFWP is more comfortable with the right bank options.

Wade stated that the USFWS also do not prefer the lock option. This option requires too much handling and potential for operator error. They prefer passive volitional passage, but they also would like to have a trapping option so that we can monitor success.

Brad and Ladd Knotek, MFWP, stated that they are somewhat concerned about walleye, although they do not think there is significant habitat for walleye upstream of Thompson

Falls Dam and walleye are already present upstream. They would want to monitor the fishway for a year to make sure we are not passing walleye. They also would like to provide passage to all species of salmonids.

The primary concerns with the full height ladder are the risks of predation and fallback. Wade said the USFWS is not particularly concerned about predation being a problem at the fishway exit into the forebay. Given the small numbers of bull trout that are likely to be passing the fishway, and the relatively large size of these fish, predation should not be a significant impact.

In addition, the USFWS is not concerned about fallback. Bull trout are bottom oriented fish and they are likely to swim to the bottom and not be swept back over the dam. In addition, more recent data in the Colombia system seems to indicate that fallback is not that detrimental to fish. In the case bull trout at Thompson Falls, a fish that falls back may have made a mistake in swimming up the fishway in the first place. Not all bull trout that approach the dam are seeking upstream sites; some overshoot their destinations.

If we did have a trap and haul facility, only bull trout would be trucked upstream, not the other species. However, the USFWS preference is to release fish on-site.

MFWP suggested that we could study fallback risk by placing radio tagged fish in the forebay where the exit from the fishway will be and see what the rate of fallback is.

Carrie Harris, PPLM, commented that they are not in favor of the left bank fishway because of exposure during high water and they do not prefer the lock because of all the moving parts.

The USFWS suggested a net pen in the forebay to collect and handle fish at the top of the ladder.

We then had a discussion about building the fishway in sections – build the lower portion first and test it, and then build the rest. However, feedback we got from the construction contractor was that it may be best to build this fishway from the top down, rather than the bottom up. In addition, it will likely be possible to build the entire project in one construction season. Steve Rainey, GEI, was unsure what part of the ladder we would leave out without impairing fish passage. He also felt building the ladder during two different time periods would not result in a cost savings and stated that this approach would be unprecedented. Jon Jourdonnais, PPLM, suggested that they evaluate this and if needed, accept the risk of constructing the entire project at once.

Design details to make the ladder more attractive to bull trout were discussed. Some suggestions were painting the ladder a dark color, and covering it.

In 2007 we will continue radio telemetry work to see if fish will approach the area of the proposed ladder entrance during the period from March through May – the prime upstream passage period – with the revised spill schedule (dated December 6, 2006).

Within a month the engineers would like the biologists to provide them with a list of functional needs for the sample loop.

The USFWS does not want the TDG issue and the downstream passage issue to slow down progress on the upstream fishway. We will work on these other issues in a small, technical group. We had a discussion of permitting and the schedule and timing for the biological assessment, biological opinion, State of Montana, and Corps of Engineers permits. The USFWS may be able to permit the fishway without necessarily addressing all the endangered species issues at the project. Our collective goal is to move ahead with the fishway and not have the schedule delayed by other issues.

5.2 Conclusion

There was consensus that the right bank full height ladder was the preferred alternative. GEI engineers will begin final design on the right bank full height ladder.

6.0 References

Federal Energy Regulatory Commission (FERC), 1990. Order Amending License (major), April 30, 1990. Project No. 1869-003 Montana. Montana Power Company.

Federal Energy Regulatory Commission (FERC), 1994. Order Amending License, March 29, 1994. Project No. 1869-018 Montana. Montana Power Company.

Appendix A – Drawings



NOTES

1. RIGHT ABUTMENT FISH LIFT OPTION NOT SHOWN

FEASIBILITY STUDY
THOMPSON FALLS
FISH PASSAGE

ppl PPL MONTANA™

GEI Consultants
Project 06008

GENERAL PLAN
OF IMPROVEMENTS

September 2006 Figure A.1

DRAFT

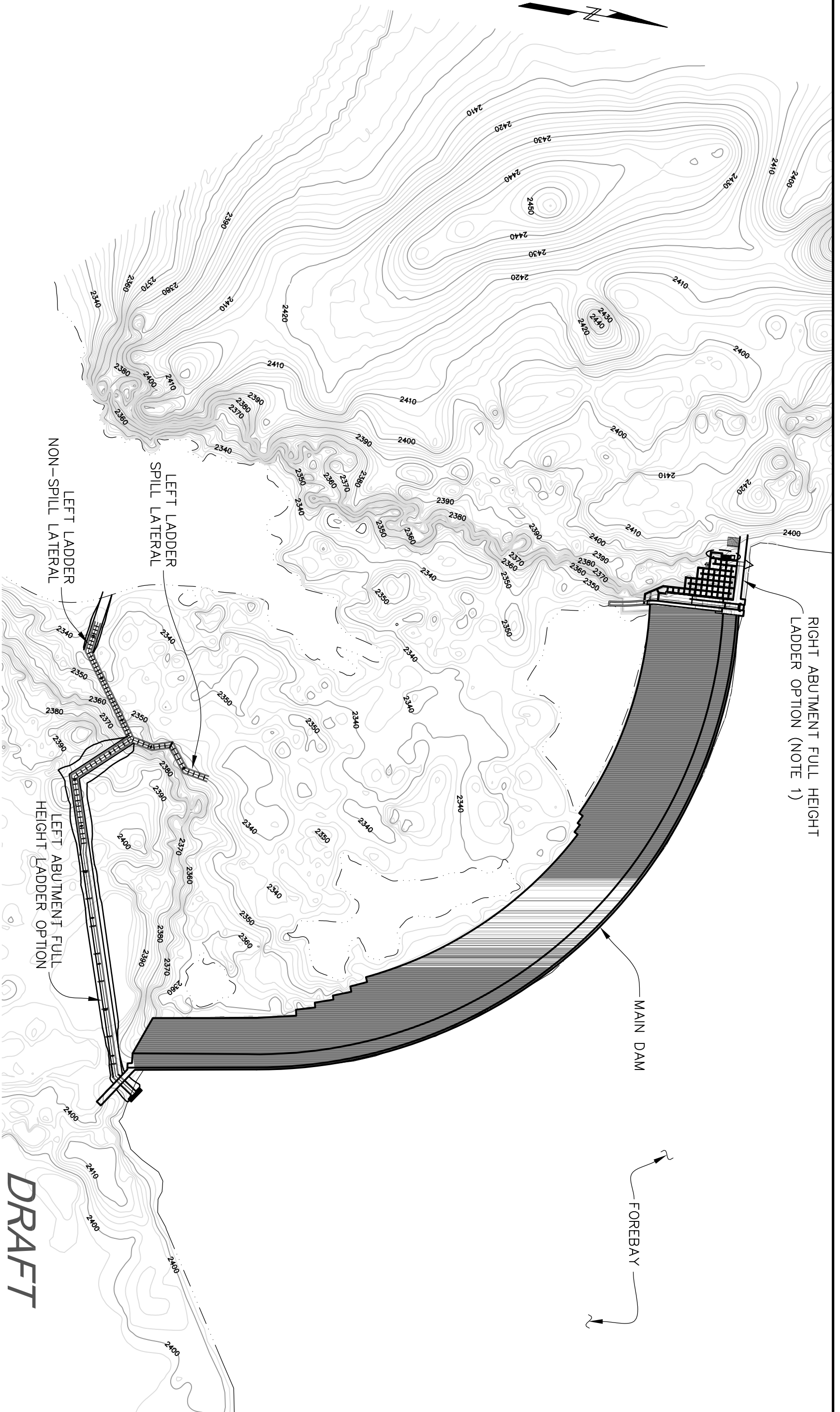

NOTES:
1. RIGHT ABUTMENT LEFT OPTION NOT SHOWN.



FEASIBILITY STUDY
THOMPSON FALLS
FISH PASSAGE
ppl PPL MONTANA™



MAIN DAM SITE PLAN
Project 06008 September 2006 Figure A.2

DRAFT

WEIR & ORIFICE NOTES

1. 2-FT WIDE NOTCHED WEIRS AT POOLS 1/2 THROUGH 44/45 (6CFS AT ΔH=1 FT)
2. ORIFICES (12" W X 14" H) AT POOLS 45/46, 46/47, AND 47/48

DESCRIPTION OF SAMPLING FACILITIES

FLOW OPERATIONS

1. TO SAMPLE, OPEN FLOW TO HOLDING POOL FROM POOL 48 (FLOW PATH NOT SHOWN) AND LOWER DIFFUSER AT ORIFICE 45/46. SCREENED OVERFLOW IN POOL 45 DESIGNED TO PASS INFLOW >6 CFS DURING SAMPLING.
2. CLOSE FLOWPATH TO SAMPLING POOL AND RAISE ORIFICE 45/46 DIFFUSER WHEN SAMPLING IS COMPLETE.

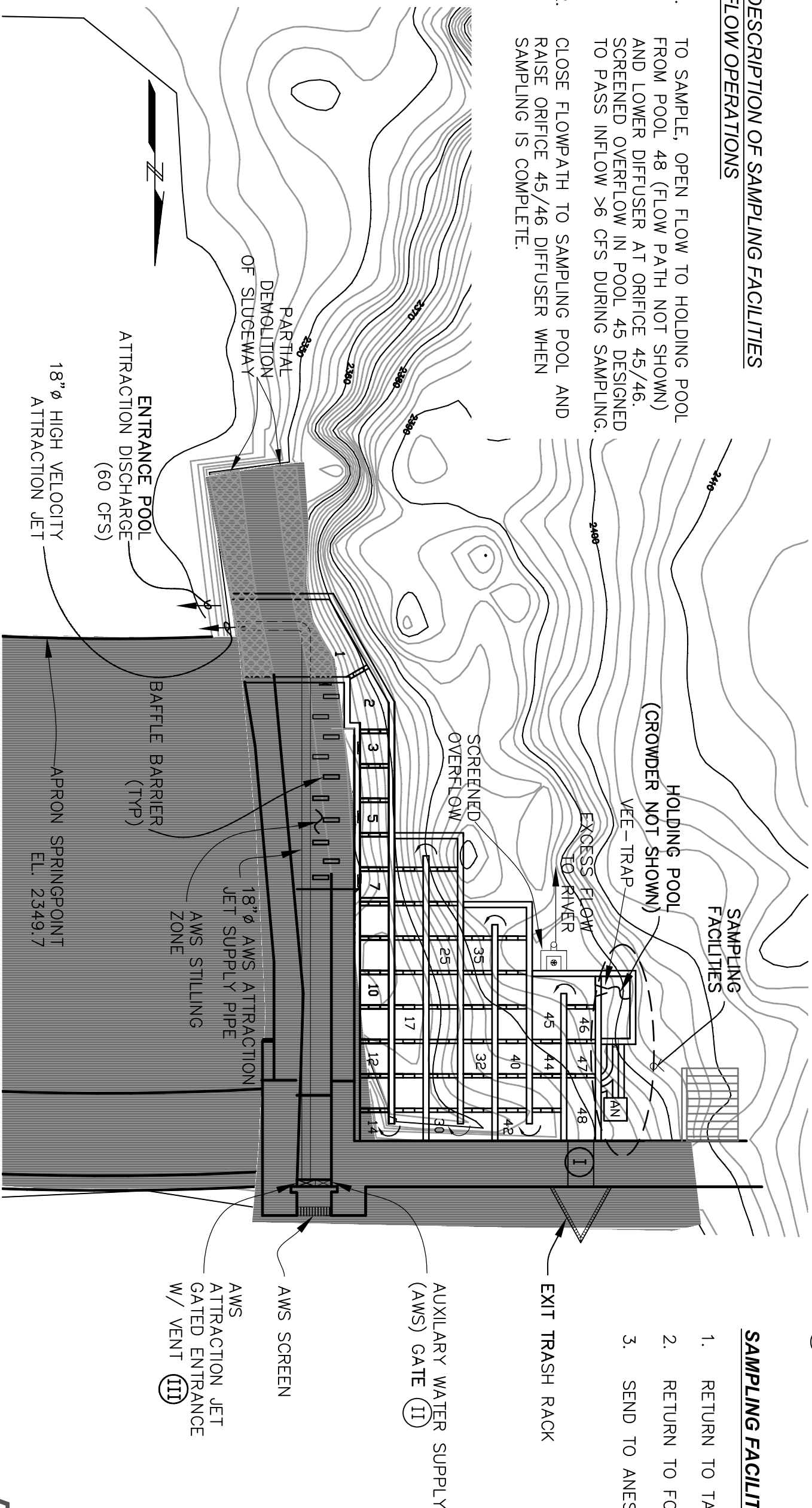

WATER SUPPLY LEGEND

- (I) FOREBAY TO EXIT LADDER (~6 CFS)
- (II) AWS TO STILLING ZONE (~54 CFS)
- (III) AWS JET TO TAILWATER (≤40 CFS)

SAMPLING FACILITIES FISH ROUTES

1. RETURN TO TAILWATER (NOT SHOWN)
2. RETURN TO FOREBAY
3. SEND TO ANESTHETIC TANK - "AN"

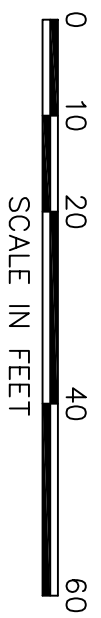

DRAFT

FEASIBILITY STUDY THOMPSON FALLS FISH PASSAGE			RIGHT ABUTMENT FULL HEIGHT LADDER - PLAN
	PPL MONTANA™		

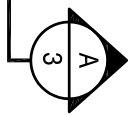
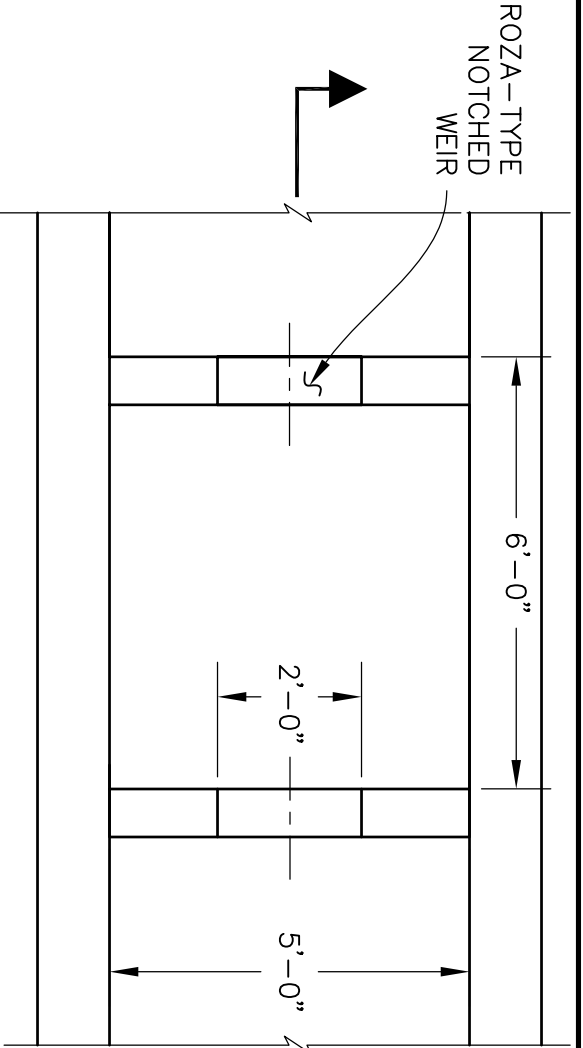

PLAN
RIGHT LADDER WEIR (TYP.)

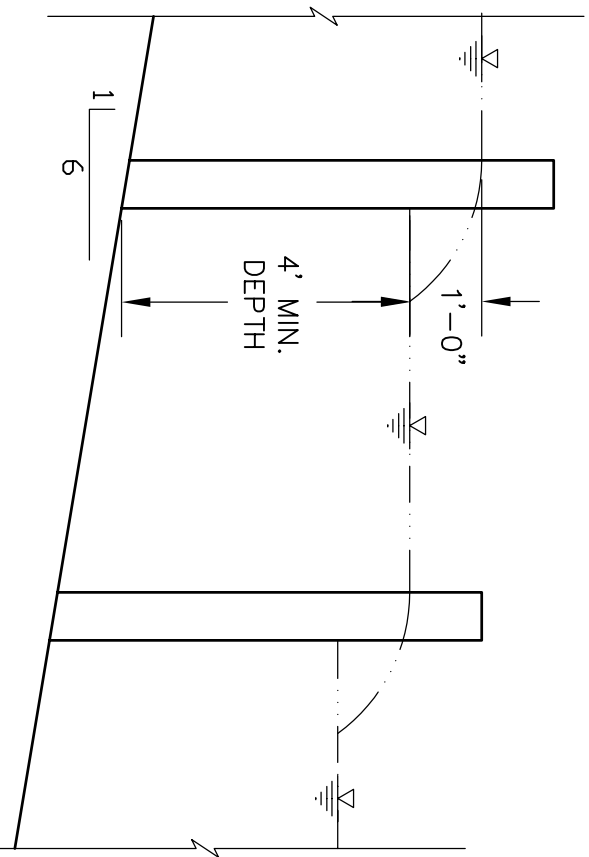

SECTION

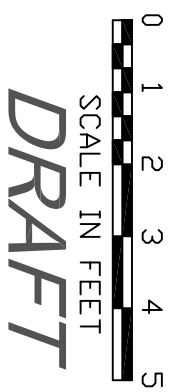
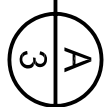

DRAFT

FEASIBILITY STUDY
THOMPSON FALLS
FISH PASSAGE

ppl PPL MONTANA™

GEI
Consultants

Project 06008

RIGHT ABUTMENT FULL
HEIGHT LADDER
AND LIFT OPTIONS -
DETAILS

September 2006 Figure A.4

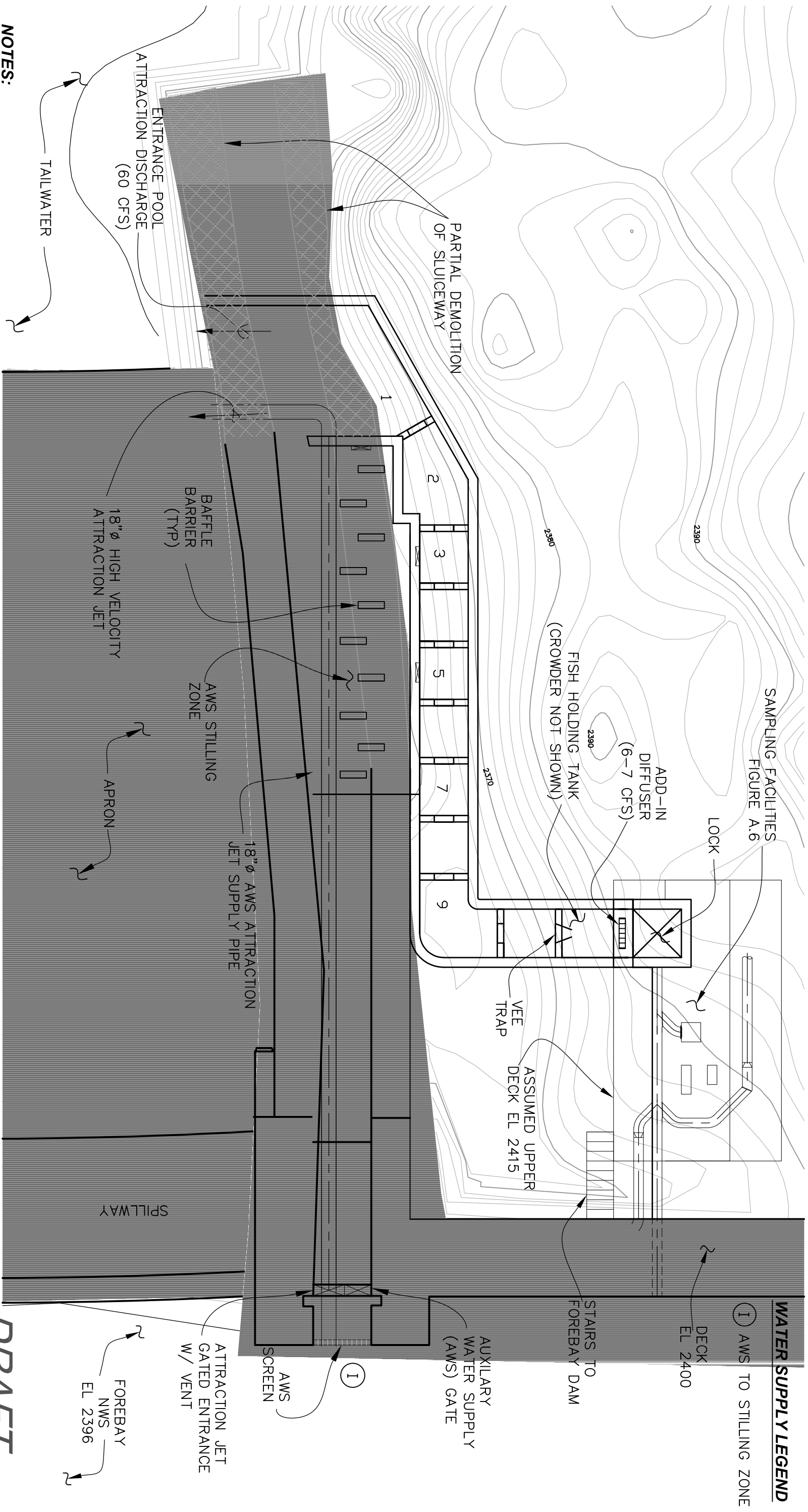

NOTES:

1. PERSONNEL ACCESS NOT SHOWN FOR LOWER LADDER POOLS, HOLDING POOL, AND LOWER LOCK.
2. MECHANICAL DETAILS NOT SHOWN.

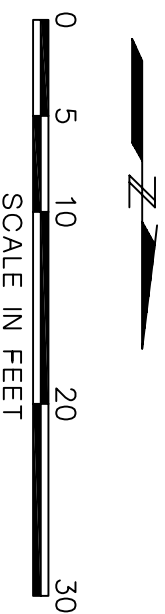

WATER SUPPLY LEGEND

① AWS TO STILLING ZONE

② DECK EL 2400

③ STAIRS TO FOREBAY DAM

④ AUXILIARY WATER SUPPLY (AWS) GATE

⑤ AWS SCREEN

⑥ ATTRACTION JET GATED ENTRANCE W/ VENT

⑦ FOREBAY NWS EL 2396

DRAFT

<p>ppl PPL MONTANA™</p>	<p>FEASIBILITY STUDY THOMPSON FALLS FISH PASSAGE</p>	<p>GEI Consultants</p>	<p>RIGHT ABUTMENT FISH LOCK - PLAN</p>
	<p>Project 06008</p>		

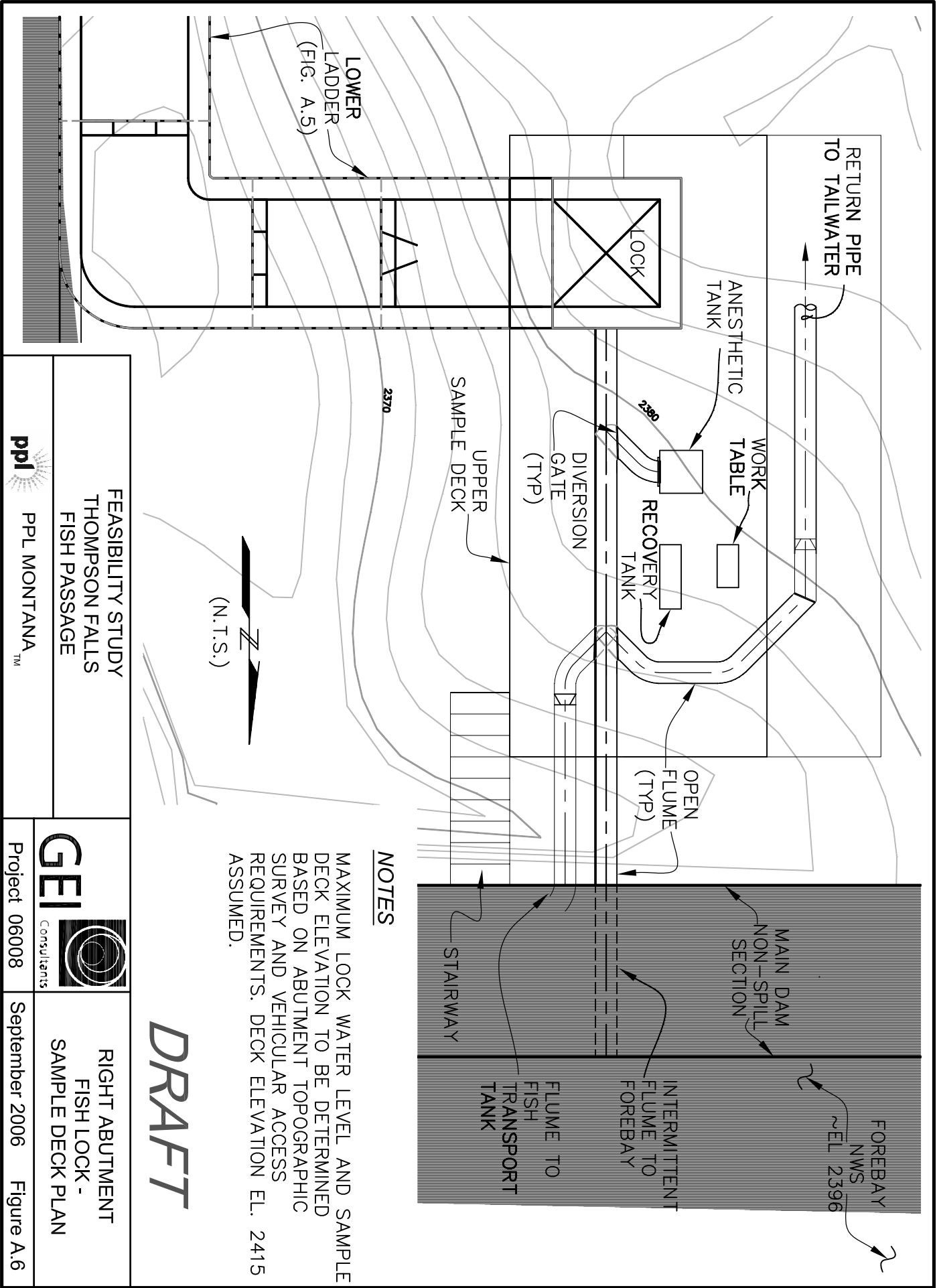

NOTES

MAXIMUM LOCK WATER LEVEL AND SAMPLE DECK ELEVATION TO BE DETERMINED BASED ON ABUTMENT TOPOGRAPHIC SURVEY AND VEHICULAR ACCESS REQUIREMENTS. DECK ELEVATION EL. 2415 ASSUMED.

DRAFT

FEASIBILITY STUDY
THOMPSON FALLS
FISH PASSAGE

ppl PPL MONTANA™

GEI
Consultants

Project 06008

RIGHT ABUTMENT
FISH LOCK -
SAMPLE DECK PLAN

September 2006 Figure A.6

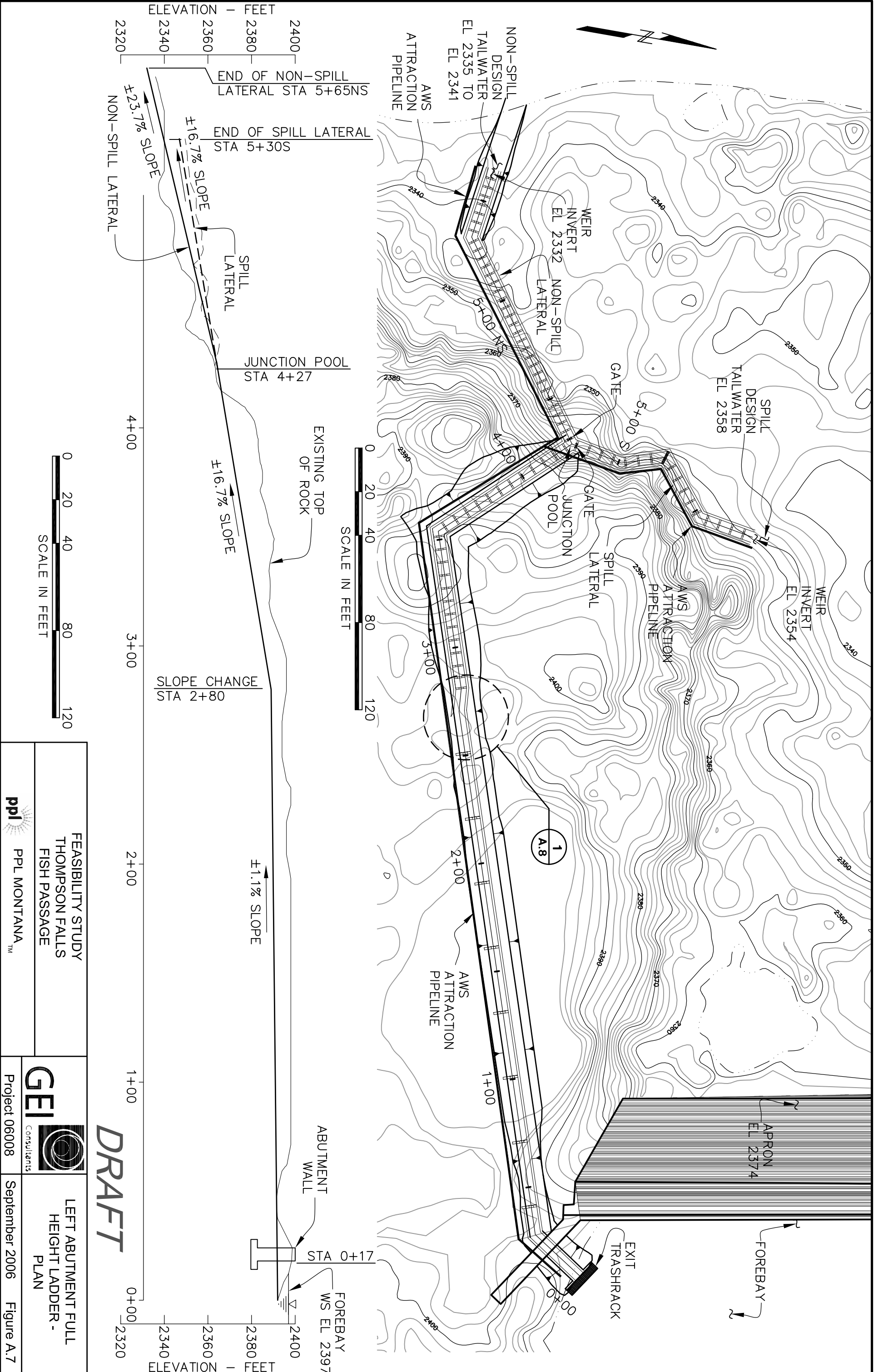

DRAFT

FEASIBILITY STUDY
THOMPSON FALLS
FISH PASSAGE

ppl PPL MONTANA™

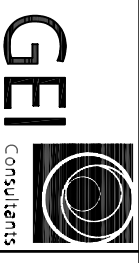

Project 06008

LEFT ABUTMENT FULL
HEIGHT LADDER -
PLAN

September 2006 Figure A.7

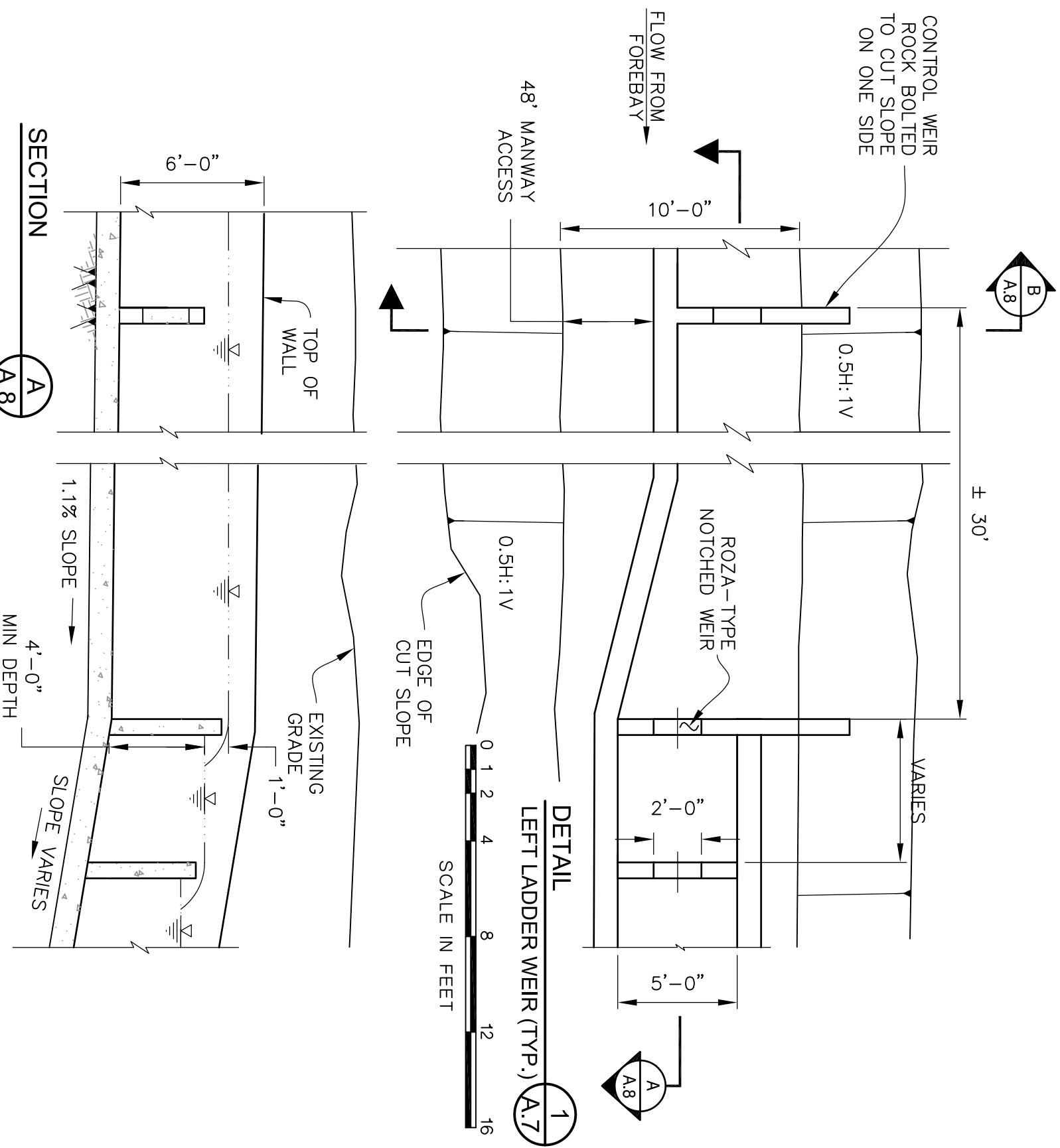
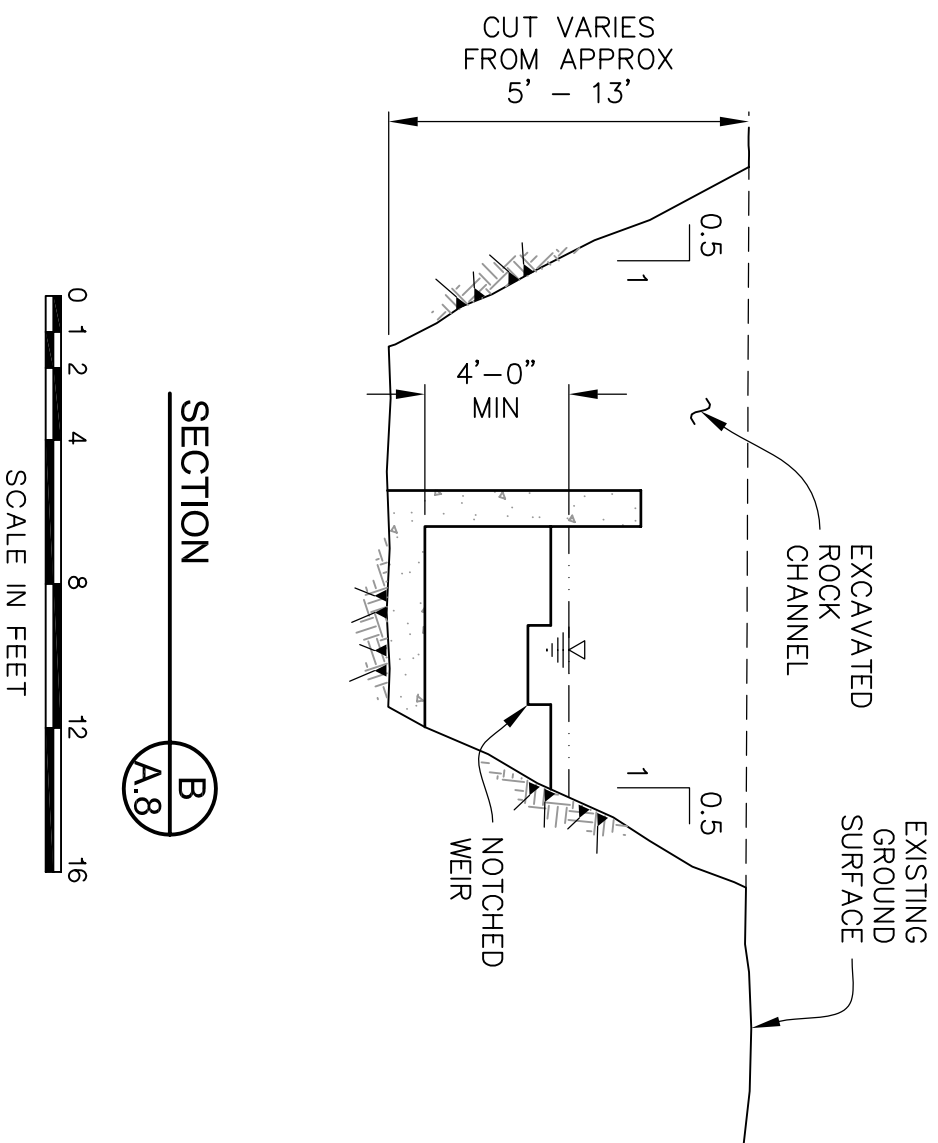

DRAFT

FEASIBILITY STUDY
THOMPSON FALLS
FISH PASSAGE

ppl PPL MONTANA™

GEI Consultants

Project 06008

LEFT ABUTMENT FULL
HEIGHT LADDER -
DETAILS

September 2006 Figure A.8

Appendix B – Thompson Falls Dam - Main Dam Spill Operating Schedule for Fish Passage – Revised December 6, 2006

The following is a description of the spill gate opening sequence that appeared to be the best combination of fish and operational needs during 2006. Spill-reduction sequence to be in the opposite order. This spill schedule is a living document, and can be updated as appropriate, on the basis of new fish or operations information.

- Spill from 0 – 700 cfs: Open lift *panels 16, 22, and 28 (right to left), in Spill Bays 3-5* as attraction for fish to the right abutment, for rising spill... (up to a total of three lift panels opened, and **total spill = 700 cfs**) - 3 total panels
- Spill from 700 – 6292 cfs: Open all lift panels, starting with #204 and (working to the *right*) extending to #181, in Spill Bays 36-33 as a deterrent to keep fish from the left abutment tailwater zone...(up to a subtotal of 24 lift panels, for a total of **5592 cfs, plus 700 cfs** attraction flow from Spill Bays 3-5, for a grand total of **6292 cfs**) – 27 total panels
- Spill from 6292 – **11,884** cfs: Open lift panels, starting with #91 and extending (to the *left*) to #114, in Spill Bays 18 - 21...(subtotal of *twenty-four* lift panels, for a total of 5592 cfs, for a grand total of **11,884 cfs**) – 51 total panels
- Spill from **11,884** – **14,680** cfs : Open lift panels, starting with #66 and extending (to the *right*) to #55, in Spill Bay 11 and 10...(subtotal of twelve lift panels, for a total of **2796 cfs**, for a grand total of **14,680 cfs**) – 63 total panels
- Spill from **14,680** – **17,476** cfs: Open lift panels, starting with #115 and extending (to the *left*) to #126, in Spill Bays 22 and 23...(subtotal of twelve lift panels, for a total of **2796 cfs**, for a grand total of **17,476 cfs**) – 75 total panels
- Spill from **17,476** – **20,272** cfs: Open lift panels, starting with #180 and extending (to the *right*) to #169, in Spill Bays 32 and 31 ...(subtotal of twelve lift panels, for a total of **2796 cfs**, for a grand total of **20,272 cfs**) – **87** total panels
- Spill from **20,272** – **23,068** cfs: Open lift panels, starting with #54 and extending (to the *right*) to #43, in Spill Bays 9 and 8...(subtotal of twelve lift panels, for a total of **2796 cfs**, for a grand total of **23,068 cfs**) – 99 total panels
- Spill from **23,068**– 27,262 cfs: Open lift panels, starting with #151 and extending (to the *left*) to #168, in Spill Bays 30 - 28...(subtotal of eighteen lift panels, for a total of **4194 cfs**, for a grand total of 27,262 cfs) – 117 total panels
- Spill from 27,262– 30,058 cfs: Open lift panels, starting with #42 and extending (to the *right*) to #31, in Spill Bays 7 and 6...(subtotal of twelve lift panels, for a total of **2796 cfs**, for a grand total of 30,058 cfs) – 129 total panels
- Spill from 30,058– 36,650 cfs: Open lift panels, starting with #127 and extending (to the *left*) to #150, in Spill Bays 24 - 27...(subtotal of 24 lift panels, for a total of **5592 cfs**, for a grand total of 35,650 cfs) – 153 total panels

- Spill from 35,650– 52,426 cfs: Open **Dry Channel** lift panels, starting with Spill Bay 1 and extending to Spill Bay 12 (or in the reverse order, at operator’s discretion), adding up to a total of **16,776** cfs, for a grand spill total of 52,456 cfs) – 153 total panels at Main Dam and 72 total panels at Dry Channel
- Spill from 52,426– 58,717 cfs: Sequentially open the remaining lift panels in Spill Bays 1 – 5 of the Main Dam (starting with lift panel #30, and extending to lift panel #1, for a total of 27 lift panels, for a total of **6291** cfs, and a grand spill total of 58,747 cfs.) – 180 total panels at Main Dam and 72 total panels at Dry Channel
- Spill from 58,717 – 64,309 cfs: Sequentially open all remaining lift panels (Spill Bays 12-15, lift panels 67-90) – for a total spill of 5592 cfs.
- Spill from 64,309 to 86,309 cfs: Open both radial gates (emergency only)

Note: It is assumed that all lift gates have a 233 cfs capacity.