



Fish Ladder Hydraulic Assessment Thompson Falls Hydroelectric Project Thompson Falls, Montana

**Federal Energy Regulatory Commission
Project #1869**

©2018 by NorthWestern Energy ALL RIGHTS RESERVED



Prepared by:

NorthWestern Energy
40 East Broadway Street
Butte, Montana 59701

With Assistance from:

GEI Consultants, Inc.
205 SE Spokane Street, Suite 341
Portland, Oregon 97202

November 2018

Table of Contents

Executive Summary	1
1.0 Introduction.....	1
1.1 Background.....	1
1.2 Project Personnel.....	2
2.0 Fish Ladder Design and Configuration.....	3
Fish Ladder Entrance.....	5
Lower Ladder Add-In Auxiliary Water Pools (Pools 2 – 7)	5
Middle Ladder Pools (Pools 8 – 44)	5
Exit-Control Section	6
3.0 Evaluation of Orifice Flow Operations.....	7
3.1 2016 Field Assessment of Orifice Flow Hydraulics	7
3.2 Qualitative Observations of Orifice Mode Ladder Operation	7
3.3 Quantitative Hydraulic Measurements of Orifice Mode Operation.....	12
3.4 Orifice Mode Measurements with Pool 45 Water Level Variations.....	17
3.5 Apparent Orifice Coefficients.....	18
4.0 Evaluation of Overflow Weir Operations	19
4.1 2017 Field Assessment of Overflow Weir Mode Hydraulics.....	19
4.2 Qualitative Observations of Current Fish Ladder Operation.....	19
4.3 Quantitative Observations of Overflow Weir Mode Ladder Operation..	25
4.4 Overflow Weir Mode Discussion on Pool 45 Operating Levels	33
5.0 Discussion of Findings	35
5.1 General	35
5.2 Orifice Mode Findings	35
5.3 Overflow Weir Mode Findings	36
6.0 Recommendations	38
7.0 Conclusions	40
8.0 References	41
Appendix A - Velocity Measurement Summaries in Orifice Mode	42
Appendix B - Velocity Measurement Summaries in Overflow Weir Mode.....	43

List of Figures

Figure 1: Thompson Falls Hydroelectric Project (Google Earth 2017).....	2
---	---

Figure 2:	Isometric and front view of aluminum weir plates. By lowering the sliding weir gate down to cover the bottom orifice, the ladder is operated in overflow weir mode.	4
Figure 3:	Thompson Falls Fish Ladder Flow Areas.....	4
Figure 4:	Calculated Apparent Orifice Coefficients	18
Figure 5:	Weir Cross Section and Measurement Nomenclature.....	26
Figure 6:	Example of velocity measurements within each pool	32
Figure 7:	Average, Minimum and Maximum Velocities in Upper Center of Each Pool	33
Figure 8:	Conceptual retrofit baffle installed approximately 18 inches downstream of weir plate.	39

List of Tables

Table 1:	Measured Pool Water Surface Elevations (Pool 45 at 2393.6)	13
Table 2:	Differential Water Surface Elevation at Weirs Between Adjacent Pools (Orifice Mode, Pool 45 at El. 2393.6).....	14
Table 3:	Maximum Measured Differential Water Surface Elevations Within Pools (Orifice Mode, Pool 45 El. 2393.6).....	15
Table 4:	Calculated Pool Volumes (Orifice Mode, Pool 45 El. 2393.6).....	16
Table 5:	Average Pool Volumes by Segment (Orifice Mode, Pool 45 El. 2393.6).....	16
Table 6:	Comparison of Orifice Flow Pool Depths/Volumes at Differing Pool 45 Levels.....	17
Table 7:	Measured Pool Water Surface Elevations in Overflow Weir Mode (Pool 45 at El. 2393.25).	27
Table 8:	Weir Differentials, Flow Depths and Weir Submergence in Overflow Weir Mode (Pool 45 at El. 2393.25)	29
Table 9:	Maximum Measured Water Surface Elevation Differential within Pool in Overflow Weir Mode (Pool 45 El. 2393.25).	30
Table 10:	Calculated Pool Volumes in Overflow Weir Mode (Pool 45 El. 2393.25)	31
Table 11:	Average Pool Volumes by Segment (Pool 45 El. 2393.25).	32

Executive Summary

The Thompson Falls Fish Ladder has been in operation since 2011 and over 31,000 fish have navigated the ladder over this period. During this time, operators have experimented with flows and operational configurations in an attempt to increase the numbers of fish swimming to the top of the ladder.

In 2016 and 2017, NorthWestern Energy conducted a ladder hydraulics study to identify if operational fine-tuning could result in a higher fish capture efficiency. During this assessment, the ladder operations were observed in two operational modes (orifice and overflow weir), and the results of those observations are presented in this report.

Based on the results of the observations and assessments, the following recommendations for improving ladder hydraulics and efficiency of fish passage should be considered:

- Unless it is beneficial to exclude non-salmonid species from ladder passage, the ladder should only be operated in orifice mode.
- The ladder operators have been running the ladder with a Pool 45 water level at El 2393.6 for orifice mode. This level is 0.6 feet above the original operating recommendation. Ladder hydraulics appear to improve at this higher Pool 45 water level. Future operation in orifice mode should occur with a Pool 45 water level at El. 2393.6.
- Ladder operators have also been running the ladder with a Pool 45 water level above the recommended El. 2393.0 level for overflow weir mode. A higher water level in overflow weir mode significantly increases ladder flow and impairs the potential for successful ladder navigation by most fish species. If the ladder is to be operated in overflow weir mode, Pool 45 should be set no higher than El. 2393.0.
- Do not operate the ladder in overflow weir mode with the Pool 7/8 and Pool 8/9 orifice PIT tag antennae installed.
- At Pool 19/20, a large drop in the hydraulic gradeline was observed, and the ladder operated at a lower depth below this elevation. NorthWestern could experiment with a smaller orifice at the Pool 18/19 weir and other weirs that may be identified as problem locations. It should be noted that adjustment of any individual pool may affect all downstream pool hydraulics.
- The ladder currently operates in an unsteady flow regime with carry-over energy increasing as flow progresses down a straight ladder segment. Internal baffles within the ladder could help dissipate more energy in each pool.

- A computational fluid dynamics (CFD) model of the ladder or select ladder segments could be developed to test different weir configurations such as alternating orifice opening sizes and locations and testing different internal baffle configurations.
- Additional PIT tag antennae could be installed along the ladder to better evaluate if certain areas of the ladder are contributing to unsuccessful passage so that efforts to modify hydraulics can be focused on these areas.

1.0 Introduction

1.1 Background

NorthWestern Energy (NorthWestern) owns and operates the 92.6-megawatt Thompson Falls Hydroelectric Project (Project), built in 1917 on the Clark Fork River near Thompson Falls, Montana (Figure 1). The Federal Energy Regulatory Commission (FERC) relicensed the Project (FERC Project No. 1869) in 1979 and amended the License to include a new powerhouse in 1990. The current FERC License is scheduled to expire on December 31, 2025.

The Thompson Falls Fish Ladder (ladder or fish ladder) was constructed between 2009 and 2010 to meet FERC license requirements, which include provisions for restoring habitat connectivity for bull trout (*Salvelinus confluentus*) along the Clark Fork River above and below the Project. Bull trout were listed as a threatened species under the Endangered Species Act in 1998. The Thompson Falls Technical Advisory Committee (TAC) was established in 2001 to play a guiding role in development of measures to protect bull trout. After several years of studies, a Biological Evaluation (PPL Montana 2008) was developed which identified factors directly related to Project operation that negatively impact bull trout in the Clark Fork River. Inhibition of upstream migration and subsequent access to spawning habitat by the Project was identified as a major concern. Consequently, the Licensee proposed to install a full-height fishway along the right bank of the Main Channel Dam at the Project and pursue upstream spawning and rearing habitat enhancement.

On October 8, 2008, the FWS issued a Biological Opinion (BO) regarding the Thompson Falls Project. The BO describes the effects of the Project on bull trout. The BO concluded that the Project is adversely effecting bull trout but would not likely jeopardize the continued existence of bull trout. The BO included an Incidental Take Statement, which includes reasonable and prudent measures, Terms and Conditions (TCs), and conservation recommendations to minimize incidental take of bull trout.

On February 12, 2009 FERC issued an Order Approving Construction and Operation of Fish Passage Facilities for the Project (FERC 2009). This Order included the reasonable and prudent measures, TCs (including the construction of a full-height fishway at the right abutment of the Main Channel Dam), and conservation recommendations from the FWS BO.

The ladder was constructed on the right side (facing downstream) of the Main Channel Dam, adjacent to the the non-overflow gravity dam section. The Main Dam is the furthest upstream impoundment structure of the Project, which also includes the original powerhouse, the new powerhouse, and the Dry Channel Dam. Figure 1 shows the general configuration of the Project.



Figure 1: Thompson Falls Hydroelectric Project (Google Earth 2017)

NorthWestern contracted with GEI Consultants, Inc. (GEI) to complete a hydraulic evaluation of the fish ladder during the 2016 and 2017 seasons to identify if any improvements to the ladder operations could be made which might increase passage efficiency. Ladder hydraulic evaluations are an important part of the normal process of fish ladder implementation at a site, which includes the following steps: design, construction, fine-tuning, and operation. Assessing hydraulic performance relative to design intent is part of the fine-tuning process. Minor modifications can then be made as necessary.

In August 2016 and August 2017, hydraulic evaluations of ladder operations were conducted in “orifice mode” and “overflow weir mode” (or “weir mode” aka “notch” mode), respectively. These two operational modes describe the flow between each of the 48 internal pools within the ladder and will be defined further in this report.

1.2 Project Personnel

Personnel from GEI responsible for the completion of this work included:

Project Manager	Ginger G. Gillin
Project Engineer	Chad M. Masching, P.E.
Fisheries Engineer	W. Steven Rainey, P.E.

2.0 Fish Ladder Design and Configuration

The reinforced concrete fish ladder was designed in general accordance with the National Oceanic and Atmospheric Administration Fisheries Criteria (NMFS, 2011), used by the U.S. Fish and Wildlife Service in the design of bull trout upstream passage facilities. Because the ladder was a pioneering structure in bull trout passage, it was designed with flexibility to allow operations of the ladder in one of two modes, identified as “orifice” and “overflow weir” modes.

The ladder was constructed with a sloping concrete floor, with 48 individual pools created by internal weir plates constructed across the concrete “U” section. Hydraulically, the ladder was designed to induce a 1-foot drop in the hydraulic grade line for each of the 48 pools to allow passage of a diverse population of fish over the Thompson Falls Main Channel Dam. Each pool is separated by an aluminum weir plate with a sliding weir gate leaf. The aluminum weir plates were designed with a sliding weir gate leaf which can be adjusted to cover a square orifice (1 foot tall by 1 foot, 2-inches wide) at the bottom center of the plate or a 2-foot-wide weir notch cut into the top of the plate.

Raising the central sliding weir gate allows pool-to-pool flow through the bottom orifice (orifice mode). Lowering the weir gate allows pool-to-pool flow to occur through the top weir (overflow weir mode). Figures 2 and 3 below show the general configurations of the weir plates in Pools 2 through 45. The upper Pools, 46, 47, and 48 operate solely in orifice mode to reduce the effects of the forebay water level on the ladder hydraulics.

The fish ladder layout at Thompson Falls was constrained due to the configuration of the existing log sluice and non-spill dam section as well as the rock abutment on the right side of the dam. In order to lay out a series of 48 pools within this geometry, a number of switchbacks and turning pools were required. By design, the fish ladder has four distinct areas, as follows:

- Fish Ladder Entrance – Pool 1
- Lower Ladder Pools – Pools 2-7
- Middle Ladder Pools – Pools 8-44
- Exit Control Section – Pools 45-48

Based on observations during the hydraulic evaluations, the middle pools could be further subdivided into an upper, lower, and switchback section. The general layout of the ladder as well as the breakout of these flow areas are shown in Figure 3, and the characteristics of the areas are described below.

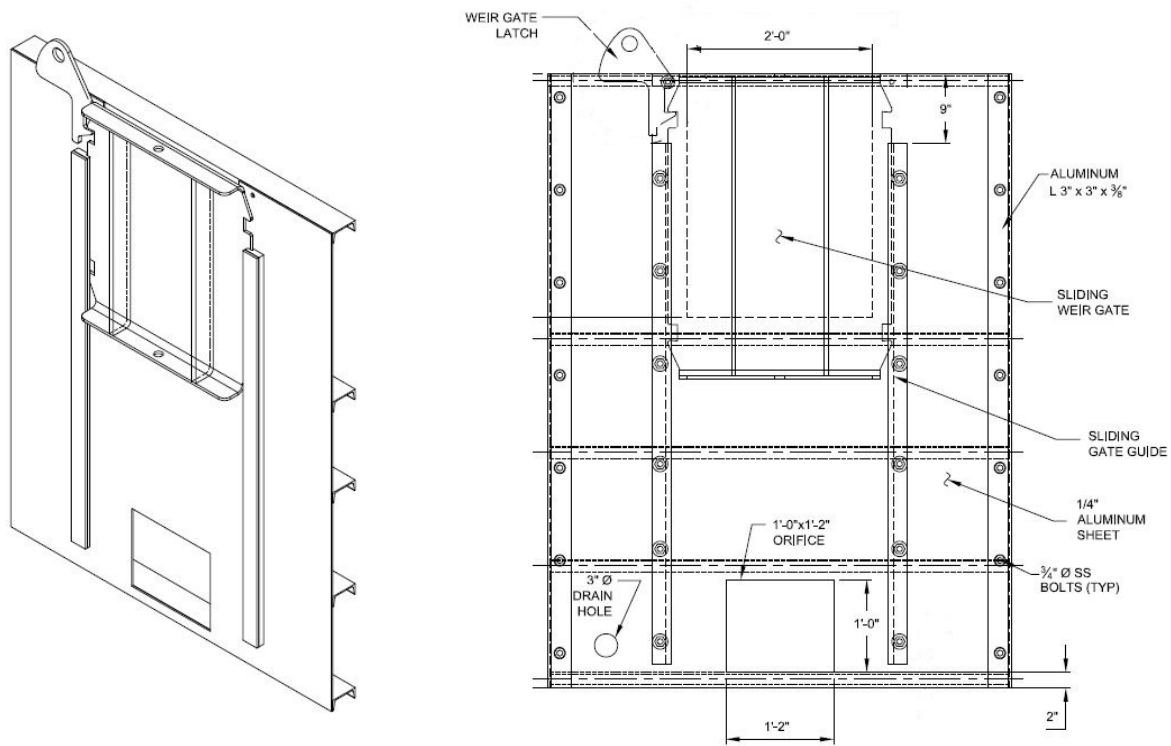

Figure 2: Isometric and front view of aluminum weir plates. By lowering the sliding weir gate down to cover the bottom orifice, the ladder is operated in overflow weir mode.

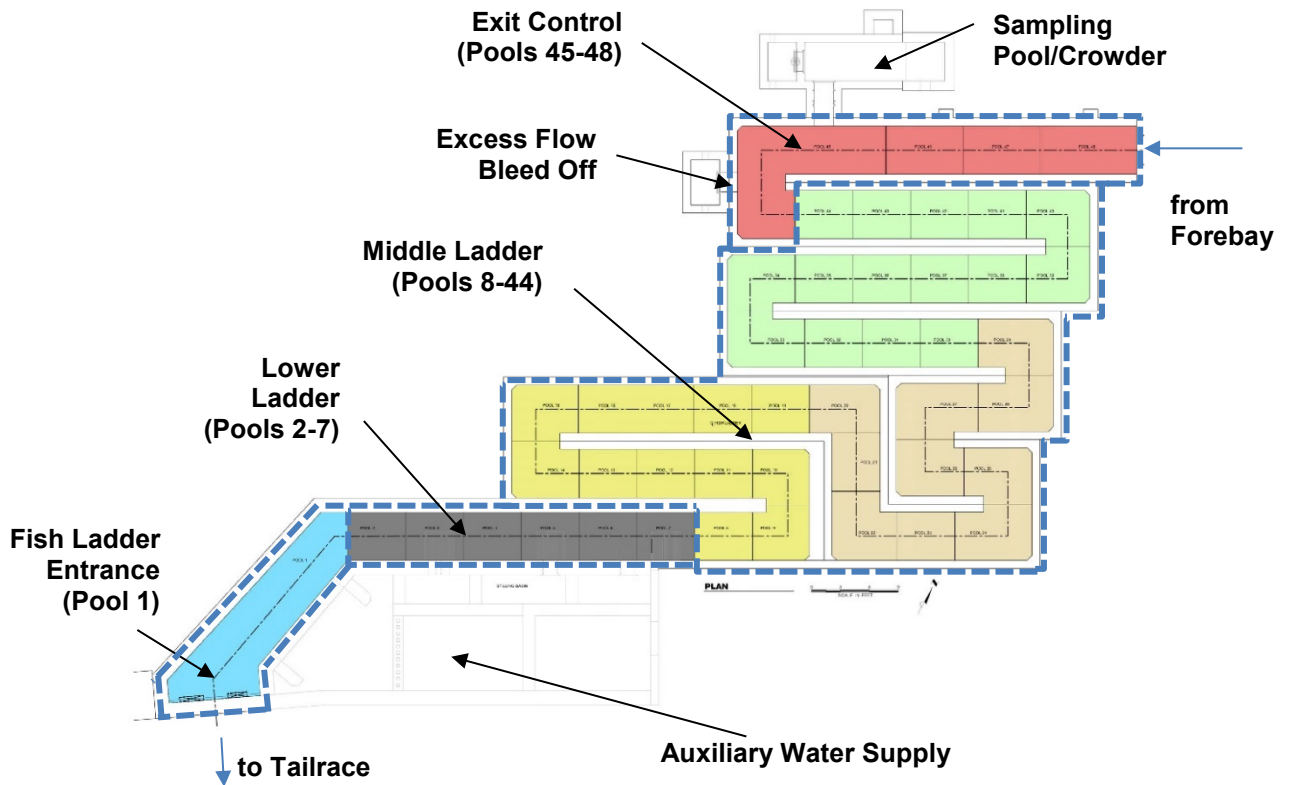

Figure 3: Thompson Falls Fish Ladder Flow Areas

Fish Ladder Entrance

- Includes two entrance ports through which fish can enter the ladder entrance pool (Pool 1): one is a gated 24-inch-wide by 36-inch-high low-tailwater (TW) entrance, designed to operate during non-spill periods; the other is a gated 30- by 48-inch high-flow entrance, designed to operate during spill. Only one entrance gate should be open at a time.
- Entrance attraction flow into the tailrace is a combination of ladder pool-to-pool flow (nominal 6 cubic feet per second [cfs]) and auxiliary water flow (maximum 54 cfs).
- An adjacent high-velocity jet provides an additional means to increase attraction flow.
- Auxiliary water supply (AWS) flow introduced into Pool 1 through a wall diffuser, with a maximum uniform velocity of 1 foot per second (fps).

The entrance pool is configured to enable fish to readily find the ladder pool-to-pool flow during the low-flow, non-spill period. During spill, auxiliary water flow is added in Pools 3, 5, and 7, successively.

Lower Ladder Add-In Auxiliary Water Pools (Pools 2 – 7)

- Fish ladder is designed to operate within design criteria between the low design TW El. 2248 and the high design TW El. 2259.
- Floor diffusers in Pools 3, 5, and 7 provide added auxiliary water successively to Pool 3, then Pool 5, then to Pool 7 as TW rises in 2-foot increments above low design TW. The purpose is to maintain fish attraction velocities/flow magnitudes over inundated weirs 2-7 during higher TW periods.
- Auxiliary water add-in system designed for weir-operation-only in these lower pools and will not add auxiliary flow if these pools are operated in orifice mode.
- Operation of Pools 2–7 should be with weir setting, regardless of whether Pools 8–45 are operated in weir or orifice mode.

Middle Ladder Pools (Pools 8 – 44)

- Fish ladder designed to operate as a pool-type ladder with a 1-foot pool-to-pool differential at a ladder flow rate of 6 cfs.
- For pool-type fish ladders, design intent is to provide pool volume to fully dissipate energy from incoming flow. An energy dissipation criterion (NMFS 2011) dictates required volume, for an appropriate turbulence level in each pool.
- Aluminum prefabricated weirs designed to enable changing from notched weir to/from orifice operating mode, by lowering/raising a gate leaf in each weir.
- Orifice and weir sizes both selected to provide a 1-foot drop in the hydraulic grade line along the ladder, based on assumed weir and orifice coefficients.

- Operating criteria also assumed a forebay elevation (El.) of 2396.0–2396.5 for normal ladder operation.
- Lower ladder flow is determined by the water surface elevation in Pool 45, whether operation is in weir or orifice mode.
- No additional auxiliary water added or removed between Pool 8 and Pool 45.

Exit-Control Section

- Three orifice Pools (45–48), designed with a drop of approximately 1 foot between pools.
- Pool 45 design elevation target of 2393.0.
- Flow to ladder pools below Pool 45 equals difference in total inflows and bleed-off outflows from Pool 45.
- Orifices between Pools 45–48 designed to modulate minor flow changes due to minor forebay pool fluctuations.
- Excessive flow into Pool 45 from forebay is bled off at a screened overflow weir, with a backset porosity control plate used to set Pool 45 water surface.
- Additional flow may be added through the trap holding pool to Pool 45.
- Upper PIT tag detector located in Pool 45 at trap holding pool.

It was observed in the 2016 and 2017 fish ladder hydraulics evaluations that the flow within the middle ladder pools (Pools 8–44) functioned with three distinct flow regimes. Pools 8 through 19 were characterized as typically having a lower water level and higher operating velocity than the switchback pools above. Pools 20 through 29 had a larger pool volume than surrounding ladder sections due to the number of turning pools. Pools 30 through 44, although similar in configuration to Pools 8 through 19, operated with a lower pool-to-pool water level differential and velocity than Pools 8 through 19.

3.0 Evaluation of Orifice Flow Operations

3.1 2016 Field Assessment of Orifice Flow Hydraulics

On August 2, 2016 GEI mobilized to the Project site to complete a hydraulic assessment of the fish ladder operating in orifice mode. The assessment was meant to both provide qualitative observations and quantitative measurements of flow conditions in each of the fishway pools. Chad Masching, PE of GEI performed the investigation along with the assistance of biologist-operators Brent Mabbott (NorthWestern Energy) and Harvey Carlsmith (Montana Fish, Wildlife and Parks). The field study was performed over a 2-day period.

At the time of the observations, the forebay was operating at El. 2396.9. The ladder was operated in weir mode for Pools 1 through 6 and in orifice mode for Pools 7 through 48. All fish were being diverted into the holding and sampling facilities at Pool 45.

3.2 Qualitative Observations of Orifice Mode Ladder Operation

Observations of actual operations during the site visit are described below, by ladder section.

Exit Control Section - Pools 45 to 48

- Forebay pool operated at El. 2396.9.
- Pool 45 operated at El. 2393.6 (0.6 feet above design) based on NorthWestern biologist' observation of improved hydraulic conditions during operation in the orifice mode in Pools 7–45.
- Operation included augmenting Pool 45 flows with flows from the holding pool which aid in running at a higher water surface elevation.
- Pool 45 water level regulated by bleeding off water through the overflow weir in Pool 45 to tailwater.
- A small vortex formed in the center of Pool 45 approximately 2 feet in front of the overflow weir screen (*see* Photo 1).
- In general, Pool 45 exhibited a large volume of non-turbulent water, sufficient for fish to hold prior to entering the crowding facilities.
- Pools 46, 47, and 48 were visually observed to have an acceptable amount of pool turbulence. However, the floor grating blocked access, so specific measurements were not taken.



Photo 1: Vortex observed in pool 45 near bleed-off diffuser.

Middle Ladder Pools (Pool 7 – Pool 45)

- NorthWestern biologists had been operating the Thompson Falls ladder in the orifice mode at pools 7–45, with Pool 45 water levels based on a cumulative 6 years of fish ladder experience and fish behavioral observations.
- Observed Pool 45 water surface elevation was 2393.6.
- During the observed orifice mode operation, flow through the bleed-off diffuser from Pool 45 resulted in a vortex in Pool 45.
- Flow from Pool 45 to 44 (and to the lower ladder) was incrementally more than the design 6 cfs, based on a 1.2-foot drop at the orifice (rather than 1.0 foot). However, back-calculated orifice coefficients varied in these ladder pools.
- Flow hydraulics were observed to vary throughout the 48 pools. At straight runs, such as from Pool 45 to 40, drops at each orifice were less than 1 foot.
- Turning pools were typically operated near the crest of the weir plates. Overtopping was noted in several turning pools.
- At turning pools, the upstream pool of a two-pool switchback exhibited less turbulence than the downstream pool. These pools share a common floor elevation, so the upstream pool is typically 1-foot deeper and has a larger volume of water.
- At the Pool 19/20 weir, the hydraulic energy of the ladder changed, and pools below operated at a water level that was approximately 1 foot lower than the pools above this weir.
- A PIT tag reader was installed in the weir between Pools 7/8 and 8/9 and was observed to have some effect on the pool hydraulics.



Photo 2: Turning pools 9 (top left) and 10 (lower left). Note increased turbulence in downstream pool.



Photo 3: Transition from turning pools to lower ladder straight pool section. This weir had the largest pool-to-pool drop of the ladder when operating in orifice mode.



Photo 4: Overflow at Pool 26/27 Weir Operating in Orifice Mode

Lower Ladder Add-In Auxiliary Water Pools (Pools 2 – 7)

- Site visit occurred during non-spill period and at the low design TW elevation.
- Weir plate between Pools 6 and 7 operated in orifice mode and therefore performed similarly to the Middle Ladder pools.
- No auxiliary flow being added through AWS floor diffusers at Pool 3, 5, and 7 due to low TW.
- Pools characterized by uniform, plunging weir flows.
- Sufficient “dark water” was observed on the left and right sides directly downstream of each weir which would allow for temporary fish holding during ladder ascent.



Photo 5: Plunging pool-to-pool weir flow typical of Lower Ladder pools

Ladder Entrance (Pool 1)

- Ladder entrance operated with both gates fully opened and water from upper gate (0.3-foot depth) plunging from the gate opening to the tailrace pool below.
- Flow within the entrance appeared to have sufficient volume and depth for the ladder flow and attraction flow.



Photo 6: Conditions at Entrance Pool with both gates fully opened

3.3 Quantitative Hydraulic Measurements of Orifice Mode Operation

The intent of the field hydraulic measurement task was to determine the impact of operating the ladder at a higher Pool 45 level and also to determine if other operational or structural modifications can and/or should be made to incrementally improve ladder hydraulics and fish passage.

The quantitative hydraulic ladder assessment consisted of pool water level measurements as well as velocity measurements. For the water level measurements, pool levels were measured at the four corners of each pool. For turning pools, an additional measurement was made at the turning pool corner. These pool measurements provided several characteristics for each pool. First, the average pool depth was calculated for each pool. Second, differentials between pool corners were also calculated, which can be used to quantify the amount of turbulence within the pool. Field measurements were taken between Pools 5 and 45. Weir pools 2, 3, and 4 could not be accessed for measurement. However, visually, these pools behaved similarly to Pools 5 through 7. The pools upstream of Pool 45 were not measured. Table 1 contains the pool water level data collected for the ladder operated in orifice mode with a Pool 45 water level at approximately El. 2393.6.

Table 1: Measured Pool Water Surface Elevations (Pool 45 at 2393.6)

Pool	Pool Water Surface Elevation (ft)						Pool	Pool Water Surface Elevation (ft)					
	US-L	US-R	DS-L	DS-R	Corner	Average		US-L	US-R	DS-L	DS-R	Corner	Average
45	2393.58	2393.58	2393.58	2393.58	2393.58	2393.58	23	2372.50	2372.42	n/a	2372.42	N/A	2372.44
44	2392.38	2392.46	2392.21	2392.17	N/A	2392.30	22	2371.04	2371.08	2371.17	2371.13	2371.25	2371.13
43	2391.88	2391.79	2391.58	2391.67	N/A	2391.73	21	2369.83	2369.92	2369.92	2369.83	N/A	2369.88
42	2391.13	2391.17	2391.04	2391.00	N/A	2391.08	20	2368.75	2368.83	2368.71	2368.75	2368.92	2368.79
41	2390.29	2390.29	2390.04	2390.13	N/A	2390.19	19	2367.33	2367.21	2367.04	2367.29	N/A	2367.22
40	2389.50	2389.50	2389.50	2389.50	2389.58	2389.52	18	2366.42	2366.38	2366.33	2366.21	N/A	2366.33
39	2388.17	2388.38	2388.46	2388.33	2388.33	2388.33	17	2365.58	2365.42	2365.21	2365.42	N/A	2365.41
38	2387.17	2387.29	2387.08	2387.00	N/A	2387.14	16	2364.54	2364.50	2364.42	2364.38	N/A	2364.46
37	2386.08	2385.88	2385.92	2386.00	N/A	2385.97	15	2363.50	2363.50	2363.58	2363.54	2363.33	2363.49
36	2385.38	2385.42	2385.29	2385.21	N/A	2385.32	14	2362.25	2362.25	2362.17	2362.25	2362.25	2362.23
35	2384.42	2384.54	2384.29	2384.38	N/A	2384.41	13	2361.04	2361.08	2360.83	2361.00	N/A	2360.99
34	2383.63	2383.67	2383.67	2383.71	2383.75	2383.68	12	2360.08	2360.08	2360.00	2359.92	N/A	2360.02
33	2382.54	2382.58	2382.63	2382.63	2382.63	2382.60	11	2359.29	2359.33	2359.08	2359.29	N/A	2359.25
32	2381.54	2381.58	2381.13	2381.38	N/A	2381.41	10	2358.29	2358.33	2358.29	2358.33	2358.33	2358.32
31	2380.33	2380.38	2380.13	2380.25	N/A	2380.27	9	2357.00	2357.13	2357.17	2357.21	2357.08	2357.12
30	2379.67	2379.71	2379.42	2379.54	N/A	2379.58	8	2356.21	2356.17	2356.00	2355.92	N/A	2356.07
29	2378.71	2378.71	2378.71	2378.75	2378.75	2378.73	7	2355.42	2355.42	2355.17	2355.33	N/A	2355.33
28	2377.75	2377.71	2377.71	2377.75	2377.67	2377.72	6	2354.17	2354.21	2354.00	2354.08	N/A	2354.11
27	2376.75	2376.75	2376.75	2376.75	2376.75	2376.75	5	2353.17	2353.00	2352.67	2352.75	N/A	2352.90
26	2375.71	2375.71	2375.67	2375.71	2375.71	2375.70	4	Pools 2, 3, and 4 Similar to Pool 5					
25	2374.71	2374.71	2374.67	2374.71	2374.71	2374.70	3						
24	2373.50	2373.58	2373.58	2373.67	2373.67	2373.60	2						

Notes: US-L = Upstream left corner; US-R = Upstream right corner; DS-L = Downstream left corner; DS-R = Downstream right corner

Table 2 provides an analysis of the water level data presented above in Table 1 and shows the water level differential between adjacent pools. As previously mentioned, the design criteria assumed that the water surface elevation difference between pools would be 1 foot. This data has been conditionally formatted to identify when adjacent pools have less than 1 foot of differential (green) and when they have greater than 1 foot of differential (red).

Table 2: Differential Water Surface Elevation at Weirs Between Adjacent Pools (Orifice Mode, Pool 45 at El. 2393.6)

Pool Weir	Differential at Weir (ft)		Pool Weir	Differential at Weir (ft)	
	Left Side	Right Side		Left Side	Right Side
45 / 44	1.21	1.13	23 / 22	n/a	1.33
44 / 43	0.33	0.38	22 / 21	1.33	1.21
43 / 42	0.46	0.50	21 / 20	1.17	1.00
42 / 41	0.75	0.71	20 / 19	1.38	1.54
41 / 40	0.54	0.63	19 / 18	0.63	0.92
40 / 39	1.33	1.13	18 / 17	0.75	0.79
39 / 38	1.29	1.04	17 / 16	0.67	0.92
38 / 37	1.00	1.13	16 / 15	0.92	0.88
37 / 36	0.54	0.58	15 / 14	1.33	1.29
36 / 35	0.88	0.67	14 / 13	1.13	1.17
35 / 34	0.67	0.71	13 / 12	0.75	0.92
34 / 33	1.13	1.13	12 / 11	0.71	0.58
33 / 32	1.08	1.04	11 / 10	0.79	0.96
32 / 31	0.79	1.00	10 / 9	1.29	1.21
31 / 30	0.46	0.54	9 / 8	0.96	1.04
30 / 29	0.71	0.83	8 / 7	0.58	0.50
29 / 28	0.96	1.04	7 / 6	1.00	1.13
28 / 27	0.96	1.00	6 / 5	0.83	1.08
27 / 26	1.04	1.04	5 / 4	Pool 2,3,4 similar to Pool 5	
26 / 25	0.96	1.00	4 / 3		
25 / 24	1.17	1.13	3 / 2		
24 / 23	1.08	1.25	2 / 1		

Note: Red indicates drop between pools greater than design 1-foot differential. Green indicates drop between pools less than design 1-foot differential. Bold weir labels indicate turning pools.

Table 3 demonstrates the maximum measured differential water surface elevation within each pool. This information can be used to quantify the degree of turbulence in each pool. The data shows that the turning pools typically exhibited the least amount of differential water surface levels within each pool.

Table 3: Maximum Measured Differential Water Surface Elevations Within Pools (Orifice Mode, Pool 45 El. 2393.6)

Pool	Maximum Differential within Pool (ft)	Pool	Maximum Differential within Pool (ft)
45	0.00	22	0.13
44	0.29	21	0.08
43	0.29	20	0.13
42	0.17	19	0.29
41	0.25	18	0.21
40	0.00	17	0.38
39	0.29	16	0.17
38	0.29	15	0.08
37	0.21	14	0.08
36	0.21	13	0.25
35	0.25	12	0.17
34	0.08	11	0.25
33	0.08	10	0.04
32	0.46	9	0.21
31	0.25	8	0.29
30	0.29	7	0.25
29	0.04	6	0.21
28	0.04	5	Pools 2, 3, 4, and 5 Similar to Pool 6
27	0.00	4	
26	0.04	3	
25	0.04	2	
24	0.17	1	Not Measured
23	0.08		

When comparing the data in Table 2 and Table 3, a trend can be observed with maximum differentials of 0.2 feet or more within an individual pool typically indicating that the pool-to-pool differential will be less than 1 foot. Generally, for internal pool differentials less than 0.2 feet, the drop between adjacent pools was greater than 1 foot.

Comparing the information between Table 2 and Table 3, a strong correlation can be made between pool-to-pool differentials less than 1 foot and greater turbulence within the pool. These lower pool-to-pool differentials are the result of incomplete energy dissipation within the pool and carryover velocity head entering the downstream pool.

Table 4 provides the calculated volume of water in each of the measured pools. The pool volumes exceed the range of recommended minimum pool volumes based on the National Marine Fisheries Service guidelines for anadromous salmonid passage (NMFS 2011). The minimum recommended pool volumes for a 1-foot differential between pools for 6 and 7 cfs is 94 cubic feet and 109 cubic feet respectively.

Table 4: Calculated Pool Volumes (Orifice Mode, Pool 45 El. 2393.6)

Pool	Volume (ft ³)	Pool	Volume (ft ³)
44	144.1	24	307.8
43	156.9	23	223.3
42	167.5	22	296.8
41	170.6	21	206.3
40	288.3	20	212.3
39	243.0	19	141.6
38	169.1	18	145.0
37	164.1	17	147.2
36	174.7	16	148.7
35	177.2	15	261.5
34	313.6	14	213.6
33	307.8	13	134.7
32	177.2	12	135.6
31	173.1	11	142.5
30	182.5	10	214.7
29	352.6	9	173.9
28	306.6	8	137.2
27	384.1	7	145.0
26	273.4	6	138.4
25	317.8	5	131.9

The following average volumes were estimated for the three intermediate ladder sections and broken out into straight pools and turning pools. Pool 21 was excluded from the volume calculations as it was the only straight pool in the Middle Ladder turning pool switchback section.

Table 5: Average Pool Volumes by Segment (Orifice Mode, Pool 45 El. 2393.6)

Ladder Segment	Average Pool Volume (ft ³)
Middle Ladder Straight Pools above Pool 20 (29-44)	169
Middle Ladder Turning Pools above Pool 29 (29-44)	288
Middle Ladder Turning Pools Switchback Section (20 to 28)	320
Middle Ladder Straight Pools Below Pool 20 (7 to 19)	142
Middle Ladder Turning Pools below Pool 20 (7 to 19)	216

Below Pool 20, the ladder operated with an average pool depth 1 foot lower than the ladder pools in Pool 20 and above.

3.4 Orifice Mode Measurements with Pool 45 Water Level Variations

As previously stated, the water level in Pool 45 sets the hydraulic conditions for all of the pools below. The ladder has been operated with a Pool 45 level typically between El. 2393.6 and 2393.7, which is 0.6 to 0.7 feet above the design operating level of this pool. A higher Pool 45 water level increases the pool-to-pool flow potential for the entire ladder. As part of this investigation, additional ladder measurements were made in select pools by NorthWestern and Montana Fish, Wildlife and Parks staff with the ladder operating at two lower Pool 45 water levels. These measurements included the design Pool 45 El. of 2392.9 (design Pool 45 El. 2393.0) and an intermediate level between the design and typical operating water levels at El. 2393.4. Table 6 contains a comparison of these measurement comparisons.

Table 6: Comparison of Orifice Flow Pool Depths/Volumes at Differing Pool 45 Levels

Pool	Pool 45 @ El 2392.9		Pool 45 @ El 2393.4		Pool 45 @ El 2393.6	
	Depth (ft)	Volume (ft ³)	Depth (ft)	Volume (ft ³)	Depth (ft)	Volume (ft ³)
43	5.13	153.8	5.50	165.0	5.23	156.9
42	4.58	137.5	5.08	152.5	5.58	167.5
40	6.96	266.9	7.42	284.5	7.52	288.3
39	5.83	223.8	4.92	188.6	6.33	243.0
37	5.58	167.5	5.92	177.5	5.47	164.1
36	5.00	150.0	5.38	161.3	5.82	174.7
34	7.42	302.7	7.75	316.3	7.68	313.6
33	6.25	291.5	6.50	303.2	6.60	307.8
31	5.96	178.8	6.21	186.3	5.77	173.1
30	5.50	165.0	5.75	172.5	6.08	182.5
28	6.42	292.9	6.75	308.1	6.72	306.6
27	7.25	359.3	7.75	384.1	7.75	384.1
25	6.67	275.2	7.50	309.6	7.70	317.8
24	5.50	256.5	6.33	295.4	6.60	307.8
22	5.08	246.0	5.83	282.3	6.13	296.8
21	5.75	172.5	6.50	195.0	6.88	206.3
20	4.83	177.1	5.42	198.5	5.79	212.3
19	3.42	102.5	4.17	125.0	4.72	141.6
15	6.25	251.8	6.50	261.9	6.49	261.5
14	5.00	204.1	5.25	214.3	5.23	213.6
11	4.92	147.5	5.17	155.0	4.75	142.5
10	6.17	209.6	6.33	215.2	6.32	214.7
8	4.83	145.0	5.00	150.0	4.57	137.2
7	4.33	129.9	4.33	129.9	4.83	145.0

The El. 2393.6 Pool 45 water level increased the average pool volume by over 10 percent compared to the El. 2392.9 water level. This was accomplished without a notable increase in

pool-to-pool flow based on differential water levels between the pools. This additional pool volume is beneficial for energy dissipation within each pool.

3.5 Apparent Orifice Coefficients

During design, pool-to-pool flow in orifice mode was assumed to be controlled by the orifice equation below:

$$Q = CA\sqrt{2gh}$$

Where Q = Flow (cfs)
 C = Orifice coefficient (constant)
 A = Orifice open area (ft²)
 g = 32.2 ft/sec
 h = differential across weir (ft)

Based on published data for orifice plates, a value of 0.6 was selected as the orifice constant. The pool-to-pool differential observed during the August 2016 flow measurements were used to estimate the apparent orifice coefficient at each weir location. Figure 4 shows that the coefficient varies along the ladder, which indicates that additional velocity head is contributing to the differences in pool differentials.

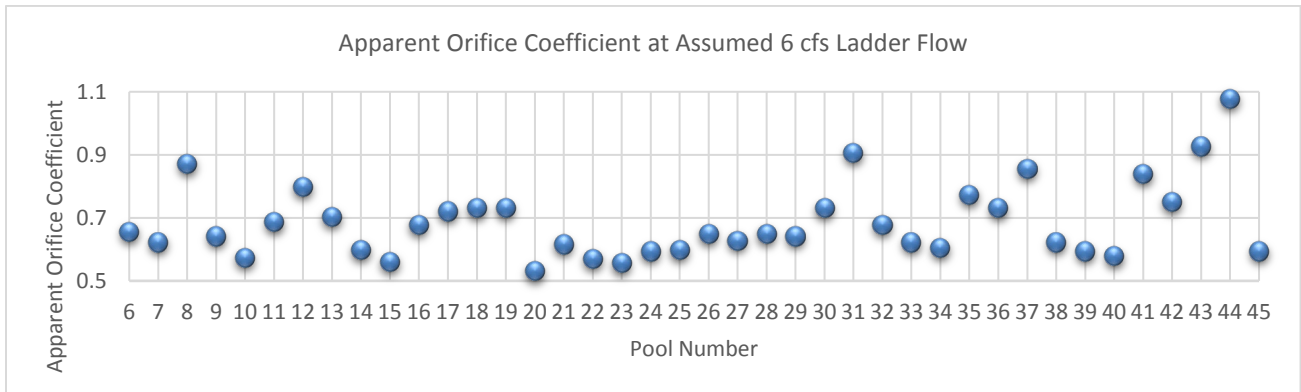

Figure 4: Calculated Apparent Orifice Coefficients

4.0 Evaluation of Overflow Weir Operations

4.1 2017 Field Assessment of Overflow Weir Mode Hydraulics

On August 1, 2017 GEI mobilized to the Project site to complete the hydraulic assessment of the ladder operating in overflow weir mode. Chad Masching, PE of GEI performed the investigation along with the assistance of biologist-operators Brent Mabbott (NorthWestern Energy) and Harvey Carlsmith (Montana Fish, Wildlife and Parks). The field study was performed over a 2-day period. The ladder hydraulics were set with the Pool 45 water level at El. 2393.25.

4.2 Qualitative Observations of Current Fish Ladder Operation

Observations of actual operations during the August 2017 site visit are described below, by ladder section. The site visit occurred during the non-spill period and at the low design TW elevation.

Exit Control Section – Pools 45 to 48

- Pool 45 operated at El. 2393.25 (0.25 feet above design).
- Operation included augmenting Pool 45 flows with flows from the holding pool/horizontal crowder, which aid in running at a higher water surface elevation.
- The bleed off gate at Pool 45 was in the closed position.
- In general, Pool 45 exhibited a large volume of non-turbulent water, sufficient for fish to hold prior to entering the crowding facilities.
- Pools 46, 47, and 48 were visually observed to have an acceptable amount of pool turbulence. However, the floor grating blocked access, so specific measurements were not taken.

Middle Ladder Pools – Pools 7 to 44

- A trend was noted with water level differentials within each pool progressively decreasing from upstream to downstream along the straight pool segments. At the turning pools, these differentials would reset a lower differential.
 - The overflow weirs at several pool-to-pool transitions had zero or negative submergence, indicating that the nappe was plunging between the pools. Although this is beneficial from an energy dissipation stance, these flow conditions coupled with velocities greater than 7 feet per second along the flowline could make passage difficult for weaker swimming species.
 - The transition from overflow weir mode in Pools 2–7, to orifice mode in pools 8 and 9 for the PIT tag readers, and back to overflow weir mode above Pool 9 causes a significant
-

disruption in the pool hydraulics. Pool differentials between Pools 9 and 10 and Pools 10 and 11 were 0.21 and 0.3 feet respectively.

- At turning pools, the downstream pool of a two-pool switchback exhibited less turbulence than the upstream pool. This is opposite of noted observations for orifice operation mode.



Photo 7: Pool 9 (lower left) and Pool 8 (mid-left) operating in orifice mode for use with PIT tag readers. Water level differential between Pools 9 and 10 was only 0.21 feet due, in part, to the presence of the PIT tag antenna.



Photo 8: Looking upstream towards Pool 14 from Pool 10.



Photo 9: Note difference in turbulence between turning pools 24 (top) and 25. Pool 25 had a plunging nappe, with a depth of flow of 1.34 feet over the upstream weir and no tailwater submergence. Pool 24 had a depth of flow of 0.83 feet over the weir with 0.3 feet of tailwater submergence.

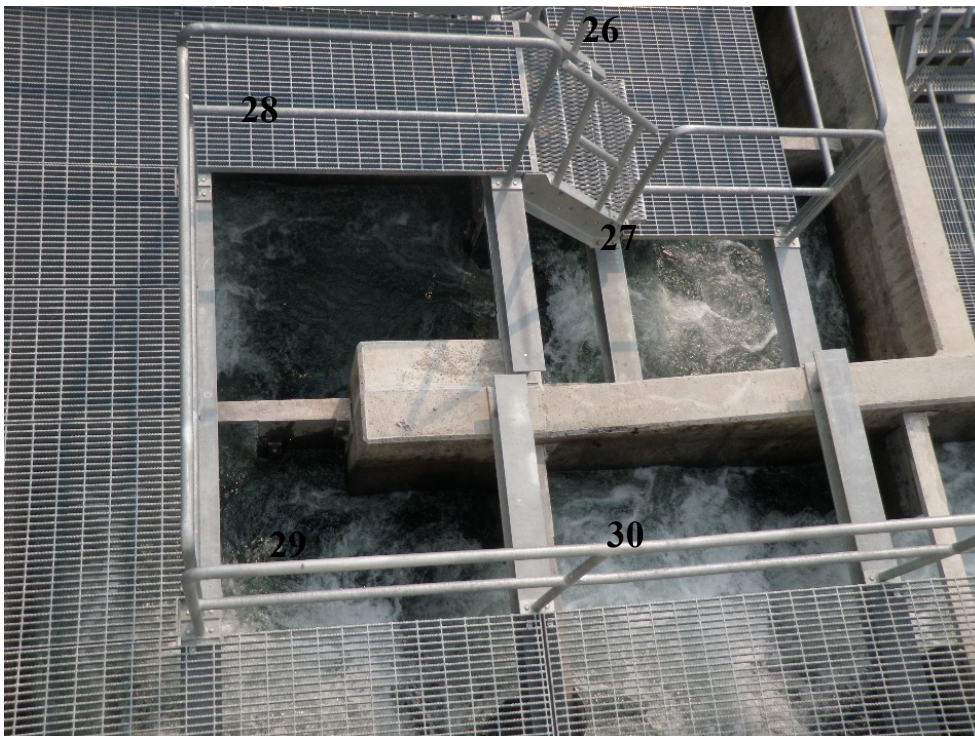

Photo 10: Beginning of switchback pools.



Photo 11: Pools 29 through 34 operating in overflow weir mode. Based on field measurements, weirs 29/30 and 30/31 exhibited pool to pool flow with about 0.3 feet of weir submergence and a differential of approximately 0.6 feet between each pool.

Lower Ladder Add-In Auxiliary Water Pools – Pools 2 to 7

- No auxiliary flow was being added through AWS floor diffusers at Pools 3, 5, and 7 due to low TW.
- Plunging weir flow between pools was similar to that observed for the 2016 study.
- Sufficient “dark water” was observed on the left and right sides directly downstream of each weir which would allow for temporary fish holding during ladder ascent.



Photo 12: Pool-to-pool overflow weir flow in lower ladder pools.

Ladder Entrance – Pool 1

- Ladder entrance operated with both gates fully opened and water from upper gate (0.3' depth) plunging from the gate opening to the tailrace pool below.
- Flow within the entrance appeared to have sufficient volume and depth for the ladder flow and attraction flow.
- Several fish were observed entering through the plunging flow of the upper entrance.



Photo 13: Conditions at Entrance Pool with high velocity attraction jet at right. Note both gates fully open and several inches of flow was passing over the upper gate.

4.3 Quantitative Observations of Overflow Weir Mode Ladder Operation

The quantitative hydraulic ladder assessment consisted of pool water level measurements as well as velocity measurements. For the water level measurements, pool levels were measured at the four corners of each pool (upstream left and right and downstream left and right). These pool level measurements provided several characteristics for each pool. First, the average pool depth was calculated for each pool by adding the measured depth to the as-built elevation at the upstream and downstream ends of each pool. Second, differentials between pool corners were also compared, which GEI has used as a proxy for the relative amount of turbulence within the pool. Pools 8 and below were not assessed during the 2017 study, as these pools were operated in weir mode similar to the 2016 orifice mode evaluation and require rope access techniques. The pools upstream of Pool 45 were also not measured due to the grating installed above these pools. Table 7 summarizes the field measurements between Pool 9 and Pool 45, adjusted to elevation. The ladder was operated in overflow weir mode, with a Pool 45 water level of approximately El. 2393.25.

Figure 5, below, is a cross section of a weir plate and showing the reported measurements.

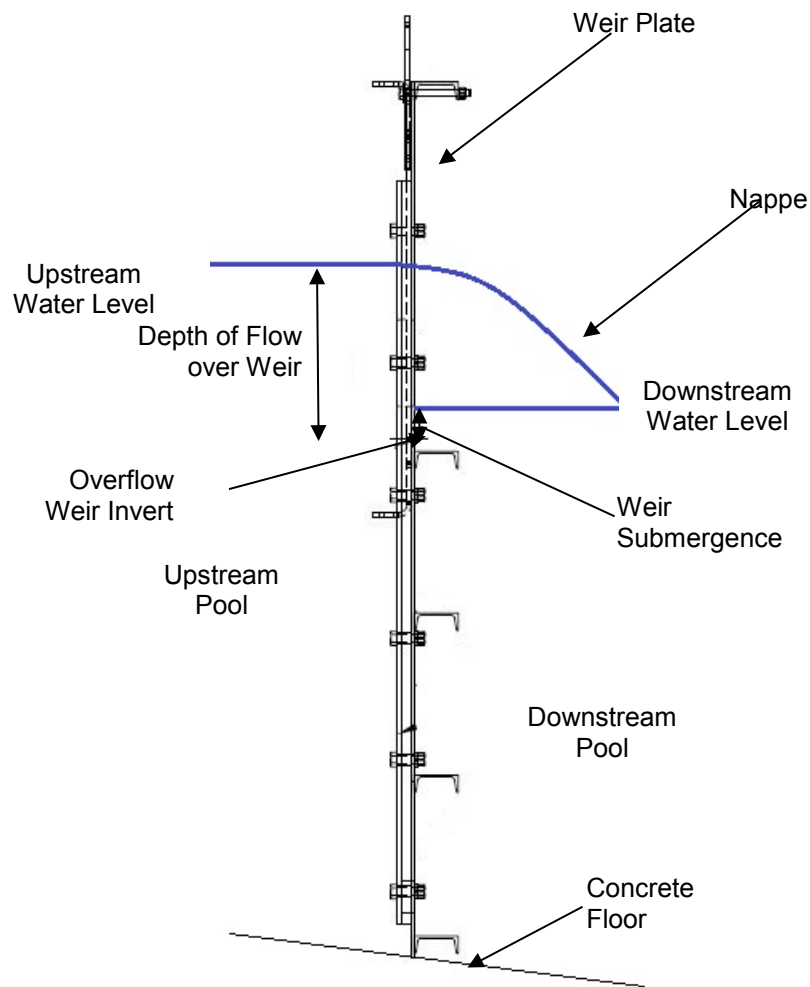

Figure 5: Weir Cross Section and Measurement Nomenclature

The field pool level measurements were added to the as-constructed pool bottom elevations to develop the water surface elevation summary in Table 7 with Pool 45 operating at El. 2393.25.

Table 7: Measured Pool Water Surface Elevations in Overflow Weir Mode (Pool 45 at El. 2393.25).

Pool	Pool Water Surface Elevation (ft)				
	US-L	US-R	DS-L	DS-R	Average
45	2393.25	2393.25	2393.25	2393.25	2393.25
44	2392.17	2392.17	2392.08	2392.00	2392.11
43	2391.17	2391.08	2391.00	2391.08	2391.08
42	2390.17	2390.17	2389.92	2390.00	2390.07
41	2389.33	2389.33	2389.00	2389.08	2389.19
40	2388.42	2388.33	2388.50	2388.50	2388.44
39	2387.42	2387.33	2387.42	2387.33	2387.38
38	2386.17	2386.17	2386.08	2386.08	2386.13
37	2385.17	2385.17	2384.92	2385.00	2385.07
36	2384.00	2383.83	2383.67	2384.00	2383.88
35	2383.33	2383.17	2382.75	2383.08	2383.08
34	2382.33	2382.58	2382.33	2382.42	2382.42
33	2381.25	2381.50	2381.50	2381.33	2381.40
32	2380.33	2380.25	2380.00	2379.92	2380.13
31	2379.00	2379.17	2378.83	2378.92	2378.98
30	2378.33	2378.25	2377.92	2378.00	2378.13
29	2377.33	2377.33	2377.50	2377.33	2377.37
28	2376.50	2376.42	2376.42	2376.42	2376.44
27	2375.42	2375.58	2375.42	2375.50	2375.48
26	2374.33	2374.42	2374.25	2374.42	2374.36
25	2373.00	2373.00	2372.83	2372.83	2372.92

Pool	Pool Water Surface Elevation (ft)				
	US-L	US-R	DS-L	DS-R	Average
23	2371.25	2371.17	2371.25	2371.25	2371.23
22	2370.33	2370.42	2370.42	2370.42	2370.40
21	2369.17	2369.17	2369.25	2369.33	2369.23
20	2368.33	2368.42	2368.42	2368.50	2368.42
19	2367.33	2367.08	2367.00	2367.08	2367.12
18	2366.25	2366.08	2365.92	2365.92	2366.04
17	2365.25	2365.25	2365.00	2364.83	2365.08
16	2364.17	2364.17	2364.00	2363.83	2364.04
15	2363.50	2363.50	2363.58	2363.75	2363.58
14	2362.33	2362.42	2362.33	2362.42	2362.38
13	2361.33	2361.42	2361.00	2361.00	2361.19
12	2360.00	2360.08	2359.83	2360.00	2359.98
11	2359.50	2359.33	2359.00	2359.25	2359.27
10	2358.83	2358.83	2358.83	2358.75	2358.81
9	2358.58	2358.58	2358.66	2358.75	2358.64
8	Pools 8 and below not measured.				
7					
6					
5					
4					
3					

Note: US-L = Upstream left corner; US-R = Upstream right corner; DS-L = Downstream left corner; DS-R = Downstream right corner. Bold weir labels indicate turning pools.

The data in Table 7 was further reduced to calculate the water surface differential between each pool, estimate the depth of flow over each weir, and estimate weir submergence. Table 8 provides a summary of this information. As previously mentioned, the design criteria assumed that the water surface elevation difference between individual pools would be 1 foot or less. This data has been conditionally formatted to identify when adjacent pools have less than 1 foot of differential (green) and when they have greater than 1 foot of differential (red). Additionally, the depth of flow over the weir is reported in the fifth column. Depths greater than 1 foot were formatted red, and depths less than 1 foot were formatted green. The last column summarizes the depth of the overflow weir submergence. A depth less than zero indicates that the nappe is plunging, increasing the difficulty for passage of poor swimming species, but increasing the energy dissipation between the pools. A preferred value of 0.25 feet was selected to accommodate poor swimming species of fish. Values greater than 0.25 feet were formatted green, and values less than 0.25 feet were formatted yellow.

Table 8: Weir Differentials, Flow Depths and Weir Submergence in Overflow Weir Mode (Pool 45 at El. 2393.25)

Pool Weir	Differential at Weir (ft)			Depth of Flow over Weir	Weir submergence (DS)
	Left Side	Right Side	Average		
45 / 44	1.08	1.08	1.08	1.25	0.17
44 / 43	0.91	0.92	0.91	1.04	0.13
43 / 42	0.83	0.91	0.87	1.04	0.17
42 / 41	0.59	0.67	0.63	0.96	0.33
41 / 40	0.58	0.75	0.66	1.04	0.38
40 / 39	1.08	1.17	1.13	1.50	0.38
39 / 38	1.25	1.16	1.20	1.38	0.17
38 / 37	0.91	0.91	0.91	1.08	0.17
37 / 36	0.92	1.17	1.05	0.96	-0.09
36 / 35	0.34	0.83	0.59	0.84	0.25
35 / 34	0.42	0.50	0.46	0.92	0.46
34 / 33	1.08	0.92	1.00	1.38	0.38
33 / 32	1.17	1.08	1.13	1.42	0.29
32 / 31	1.00	0.75	0.88	0.96	0.09
31 / 30	0.50	0.67	0.59	0.88	0.29
30 / 29	0.59	0.67	0.63	0.96	0.33
29 / 28	1.00	0.91	0.95	1.42	0.46
28 / 27	1.00	0.84	0.92	1.42	0.50
27 / 26	1.09	1.08	1.09	1.46	0.38
26 / 25	1.25	1.42	1.34	1.34	0.00
25 / 24	0.41	0.66	0.53	0.83	0.30
24 / 23	1.17	1.16	1.16	1.38	0.21

Pool Weir	Differential at Weir (ft)			Depth of Flow over Weir	Weir submergence (DS)
	Left Side	Right Side	Average		
23 / 22	0.92	0.83	0.88	1.25	0.38
22 / 21	1.25	1.25	1.25	1.42	0.17
21 / 20	0.92	0.91	0.91	1.29	0.38
20 / 19	1.09	1.42	1.26	1.46	0.21
19 / 18	0.75	1.00	0.88	1.04	0.17
18 / 17	0.67	0.67	0.67	0.92	0.25
17 / 16	0.83	0.66	0.74	0.92	0.17
16 / 15	0.50	0.33	0.41	0.92	0.50
15 / 14	1.25	1.33	1.29	1.67	0.38
14 / 13	1.00	1.00	1.00	1.38	0.38
13 / 12	1.00	0.92	0.96	1.00	0.04
12 / 11	0.33	0.67	0.50	0.92	0.42
11 / 10	0.17	0.42	0.30	1.13	0.83
10 / 9	0.25	0.17	0.21	1.79	1.60
9 / 8	Pools 8 and below not measured.				
8 / 7					
7 / 6					
6 / 5					
5 / 4					
4 / 3					
3 / 2					
2 / 1					

Notes: Differential at weir – Red indicates greater than 1 foot; Green indicates less than 1 foot
 Depth of flow over weir – Red indicates greater than 1 foot; Green indicates less than 1 foot
 Weir submergence – Green indicates greater than 0.25 foot; yellow indicates less than 0.25 foot

Table 9 demonstrates the maximum measured differential within each pool. This information can be used to quantify the relative degree of turbulence in each pool. The data shows that the turning pools typically exhibited the least amount of differential water surface levels within each pool.

Table 9: Maximum Measured Water Surface Elevation Differential within Pool in Overflow Weir Mode (Pool 45 El. 2393.25).

Pool	Max Differential w/in Pool (ft)	Pool	Max Differential w/in Pool (ft)
45	0.00	22	0.09
44	0.17	21	0.16
43	0.17	20	0.17
42	0.25	19	0.33
41	0.33	18	0.33
40	0.17	17	0.42
39	0.09	16	0.34
38	0.09	15	0.25
37	0.25	14	0.09
36	0.33	13	0.42
35	0.58	12	0.25
34	0.25	11	0.50
33	0.25	10	0.08
32	0.41	9	0.17
31	0.34	8	Pools 1 through 8 not measured
30	0.41	7	
29	0.17	6	
28	0.08	5	
27	0.16	4	
26	0.17	3	
25	0.17	2	
24	0.25	1	
23	0.08		

Table 10 provides the volume of water in each of the measured pools.

Table 10: Calculated Pool Volumes in Overflow Weir Mode (Pool 45 El. 2393.25)

Pool	Volume (ft ³)	Pool	Volume (ft ³)
44	138.2	26	218.5
43	137.5	25	244.1
42	137.0	24	248.8
41	140.5	23	186.9
40	247.0	22	261.2
39	206.2	21	186.9
38	138.8	20	198.6
37	137.0	19	138.7
36	131.3	18	136.3
35	137.5	17	137.5
34	261.8	16	136.3
33	251.6	15	265.2
32	138.8	14	219.4
31	134.4	13	140.6
30	138.8	12	134.3
29	290.9	11	143.1
28	248.3	10	231.4
27	321.1	9	225.7

The pool volumes fall within the range of recommended minimum pool volumes based on the National Marine Fisheries Service guidelines for anadromous salmonid passage (NMFS 2011). The minimum recommended pool volumes for a 1-foot differential between pools for 6 and 7 cfs is 94 cubic feet and 109 cubic feet respectively.

Table 11 shows average pool volumes that were estimated for the three intermediate ladder sections, broken out into straight pools and turning pools. Pools 21 and 23 were excluded from the volume calculations as they were the only straight pool in the Middle Ladder turning pool switchback section. Both of these pools had a volume of 187 ft³.

Table 11: Average Pool Volumes by Segment (Pool 45 El. 2393.25).

Ladder Segment	Average Pool Volume (ft ³)
Middle Ladder Straight Pools above Pool 29 (29-44)	137
Middle Ladder Turning Pools above Pool 29 (29-44)	251
Middle Ladder Turning Pools Switchback Section (20 to 28)	249
Middle Ladder Straight Pools Below Pool 20 (9 to 19)	138
Middle Ladder Turning Pools below Pool 20 (9 to 19)	235

When compared to the pool volumes calculated from the 2016 orifice mode study, pools 20 and above were operated with 15 to 30 percent less pool volume in overflow weir mode. Pools 9 through 19 had approximately the same volume. However, in the 2016 study the Pool 19/20 weir was noted as a hydraulically problematic area with a 1.45-foot drop occurred between the pools. The pools below this weir all functioned at a lower hydraulic gradeline.

Velocity Evaluations

Velocities were measured using a handheld velocity meter with a probe mounted to a PVC pipe. Measurements were set to average over a 10-second duration with the meter and were taken at depths approximately one-third of the pool height from the bottom and top of each pool respectively. Nine measurements were taken at each water level between the Left/Center/Right and Upstream/Middle/Downstream portions of each pool. The velocities were plotted as shown in the example for Pool 35 below. All measured pool velocities are included in Appendix A.

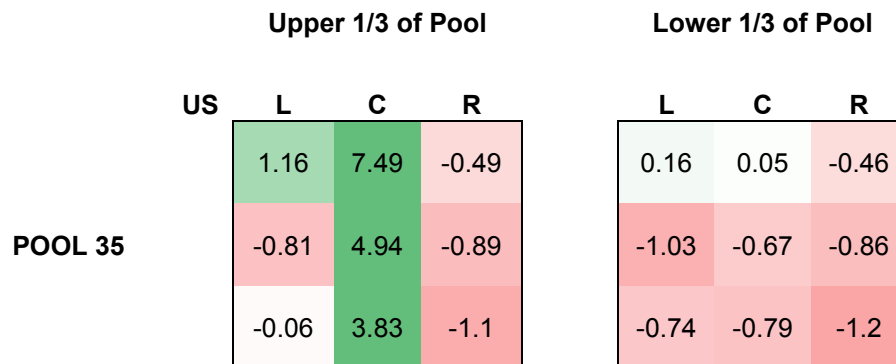

Figure 6: Example of velocity measurements within each pool

The recorded velocities were typically greatest just downstream of each weir plate, with a maximum velocity of 9.0 ft/s measured at the upstream end of Pool 36. It can be seen from the figure above that the velocity is concentrated in the upper middle flowline between the overflow weirs.

The average, minimum and maximum recorded velocities in the upper middle channel for each pool is plotted in Figure 7, below.

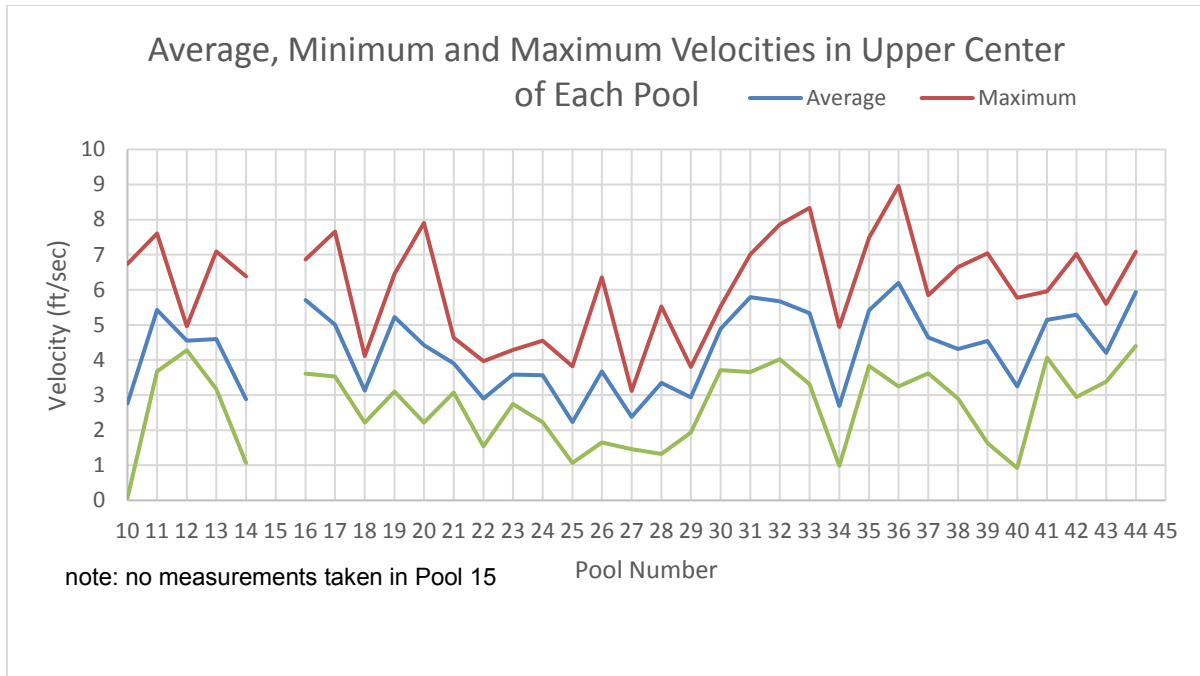

Figure 7: Average, Minimum and Maximum Velocities in Upper Center of Each Pool

4.4 Overflow Weir Mode Discussion on Pool 45 Operating Levels

During the 2016 evaluation in orifice mode, it was observed that the ladder was being operated with a Pool 45 elevation at 2393.6, which was 0.6 feet above the design operating level. The water level in Pool 45 controls the hydraulic gradeline for all downstream pools. It was noted that operating at this level in orifice mode did not have adverse hydraulic impacts on the fishway and actually provided additional volume within each pool to dissipate energy. However, for overflow weir operation, the Pool 45 level is critical to fine tuning the hydraulic operations of the ladder. The general equation assumed for pool to pool flow for operation in overflow weir mode is the sharp crested weir equation,

$$Q = \frac{2}{3} C_w \sqrt{2g} L h^{3/2}$$

in which Q is the flow, C_w is a weir coefficient (approximately 0.62), g is the gravitational constant (32.2 ft/sec²), L is the horizontal width of the weir notch (2 feet), and h is the height of water flowing over the weir notch. For orifice flow, the equation,

$$Q = C_o A \sqrt{2gh}$$

was used to approximate flow, where C_o is an orifice coefficient (averaged about 0.69), A is the cross-sectional area of the orifice (1.17 ft²), g is the gravitational constant, and h is the height of the water above the vertical mid-point of the orifice opening. It can be observed when comparing these two equations that changes in Pool 45 water level with the lower pools operating in overflow

weir mode has a greater impact on the flow of water in the downstream pools. The equations below have been reduced to show the relationships between the two operating modes and the pool-to-pool differential.

$$\text{Overflow Weir Equation } Q = 6.64h^{1.5}$$

$$\text{Orifice Mode Equation } Q = 6.47h^{0.5}$$

Operating the fishway at a Pool 45 level above El. 2393.25 in overflow weir mode is not recommended.

5.0 Discussion of Findings

5.1 General

Pool turbulence correlates with energy expended by fish trying to ascend a pool fishway. If there is excessive turbulence in enough pools, fish will not have adequate pool volume at the periphery to allow resting before ascending to the next pool. The studies indicate that there is more than enough volume in each pool to allow adequate energy dissipation, assuming a 1.0 foot drop per pool. However, the incoming weir/orifice jet for each pool needs to be directed/dispersed in a manner that utilizes more of the submerged pool volume to dissipate energy.

Pool type fish ladders are designed for normal flow conditions, where weir or orifice pool differentials are uniform and steady, with a uniform drop (1 foot for Thompson Falls) between pools. Unsteady flow conditions occur when there is a drawdown or backwater hydraulic condition in a channel. Table 2 and Table 8 (for orifice and overflow weir mode respectively) show drawdown like conditions in straight pool sections, with velocities increasing between turning pools. A backwater like condition occurs at turning pools, as weir depths increase, and incoming velocity head is absorbed. Initial ladder operations observed in 2016 and 2017 hydraulic assessments suggest that the ladder flow is unsteady in both operating modes.

5.2 Orifice Mode Findings

- Hydraulic conditions were observed throughout the fish ladder.
- The change in hydraulics at the Pool 19/20 weir may affect passage.
- Operation in pools 45–48 has evolved to where the Pool 45 water surface is at El. 2393.6, which is 0.6 ft higher than the design El. of 2393.0. This has a direct influence on orifice flow to Pool 44 (and the lower ladder).
- Based on hydraulic observations of the ladder operating with Pool 45 at El. 2393.6 and comparisons of data at lower Pool 45 water levels, the El. 2393.6 operating level is improving pool-to-pool hydraulics by providing an additional volume of water for energy dissipation
- Operating the forebay at a higher water level is not detrimental to ladder operations as additional water can be bled off at the Pool 45 overflow weir. If the ladder is operated as a passive fish ladder (no crowding/sampling) in the future, this condition may need to be re-evaluated.
- Pools 2–7 operate correctly at the observed low design tailwater elevation, with no auxiliary water being added to floor diffusers in Pools 3, 5, and 7. As spill commences, and tailwater rises, the auxiliary water system is designed to pass some of the auxiliary flow over chimneys and through floor diffusers at the referenced pools. Hydraulic conditions in Pools 2–7 were satisfactory during the site visit, and as the system is designed for passive operation, there is no perceived need for hydraulic changes at these pools. At high TW conditions, the Pool 6/7 weir should operate in weir mode.

- The entrance pool, Pool 1, received flow from both the upper ladder, and the auxiliary water wall diffuser. Although the two fishway entrance gates were open simultaneously, in contrast with operation listed in the fishway operating manual, there is not a perceived need for changes to hydraulic conditions at the entrance pool during low tailwater.
- Although fish passage counts at the upper ladder trap are substantial, hydraulic conditions in Pools 7 to 44 were observed to vary from as low as 0.33 feet to as high as 1.54 feet between pools. This is outside of the assumed 1-foot pool-to-pool drop. These conditions can potentially be improved to provide a more uniform drop throughout the ladder.
- Lower weir differentials appear to be primarily at straight runs of successive pools, while greater differentials are generally at turning pools. This suggests that there is energy carry-over from pool to pool at straight runs, where one orifice jet does not fully expand and dissipate energy before passing through the next downstream orifice. At turning pools, jets with excessive carry-over velocities/energy are slowed, creating an upwell, and dissipating carry-over energy from straight-pool runs. Note that this is not consistent at all straight pool runs nor all turning pools.
- Pool 7–44 hydraulics do not currently fully dissipate energy in each pool, due to carry-over energy (and higher orifice coefficients) at some straight run pools. This occurs despite there being sufficient volume in each pool to dissipate incoming energy. Diffusing this jet would enable energy to be absorbed by the submerged volume in each pool.
- Minor improvements to the fishway could increase the percent of salmonids which successfully navigate the fish ladder from the entrance pool to the trapping facilities.
- It is unknown at what point the majority of salmonids that do not reach the holding pool turn back. However, based on analysis of the 2016 ladder PIT tag data assessing the time spent in the ladder above Pool 8, it appears that some salmonids pass Pool 8 for a brief time and then return downstream. This indicates that some portion of salmonids may turn downstream prior to passing Pool 20.

5.3 Overflow Weir Mode Findings

- In 14 of the 35 measured pools, the depth of weir submergence (backwater depth from the downstream pool compared to the invert of the weir) was less than 0.25 feet. In four locations, the submergence was less than 0.1 feet, and at the Pool 37/36 weir, the weir flow was actually plunging into Pool 36 by approximately 0.1 feet. The combination of high velocity (9 ft/sec) and plunging flow in this pool alone could be challenging to weak swimming fish.
- Operation of the fish ladder in orifice mode allows the operator to run the facility with Pool 45 set at a higher level which increases the volume of water in each pool without significantly increasing the pool-to-pool flow. This provides greater energy dissipation between the pools. Pool volumes in the 2016 orifice mode study were 15 to 30 percent higher than volumes in overflow weir mode observed in the 2017 hydraulic study.
- There appears to be a slight reduction in passage for salmonid species when operating in overflow weir mode. However, salmonids can navigate the ladder when operating in this mode. Operating the ladder in overflow weir mode had a significant reduction in total fish count with the ladder, as non-salmonid species were largely excluded from passage.

- Carryover energy from straight pool sections was indicated by increased flowline velocities and lower differential water levels between pools as the pools move downstream. Internal baffles could provide flow disruption and dissipate additional energy between pools.
- The entrance pool, Pool 1, received flow from both the upper ladder, and the auxiliary water wall diffuser. Although the two fishway entrance gates were open simultaneously, in contrast with operation listed in the fishway operating manual, there is not a perceived need for changes to hydraulic conditions at the entrance pool.
- Pools 2–7 operated similar to the conditions observed in orifice weir mode.

6.0 Recommendations

The Thompson Falls fish ladder has an overall higher capture efficiency when operating in orifice mode. Overflow weir mode excludes passage of most sucker, whitefish, and pikeminnow species during periods of high movement of these fish, but results in only a marginal reduction in salmonid passage. Operation of the ladder in overflow weir mode above the design Pool 45 water level increases the pool-to-pool flow and is not recommended. To immediately improve efficiency, the ladder should be operated exclusively in orifice mode.

Modifications to the fish ladder to improve the hydraulic conditions could include reduction in the weir length in certain problematic overflow weirs, modifications to the cross-sectional opening for certain orifices, and installation of internal baffles. The transition between overflow weir mode to orifice mode and back to overflow weir mode between Pools 7 and 10 for the PIT tag readers creates non-desirable flow hydraulics. It is recommended that any modifications to the weir and pool configurations be focused on improving hydraulic conditions for orifice mode.

Installation of one or more additional PIT tag arrays in the ladder could help better identify if there is a specific ladder element that is contributing to unsuccessful passage attempts. A ladder antenna array similar to that installed at Pools 7, 8, and 45 could be installed at Pool 29/30 to provide an additional data point above the Middle Ladder turning pool switchbacks. An additional antenna could be installed in Pool 19, just downstream of the Pool 19/20 weir. However, this location already has complicated ladder hydraulics. Biomark manufactures a plate type PIT tag antenna that has a read range of approximately 14 inches and has a thickness of approximately 2 inches. This type of antenna should be sized to sufficiently identify the presence of a PIT tagged fish navigating through the orifice at Pool 19/20 without adversely affecting the pool hydraulics. This type of antenna would not work if the Pool is operated in weir mode. If the ladder is to be operated in overflow weir mode, new PIT tag antennae should be installed in weirs 7/8 and 8/9 which allow overflow weir operation.

Additionally, pool hydraulics in orifice mode could be adjusted by modifying the size of the orifice opening control the pool-to-pool drop. NorthWestern could experiment with a smaller orifice at the Pool 18/19 weir by fabricating a 2'-5" wide x 1'-6" wide ¼-inch aluminum plate with smaller orifices (1-foot-high x 1-foot-wide and 1-foot-high x 10-inches-wide) to determine if the depth in the lower middle ladder pools can be increased. Temporary plywood orifice inserts could be used for a short-term assessment of different configurations. This modification may only be required along the straight ladder pools to induce a greater pool-to-pool drop in these ladder pools.

Because carryover velocity in the straight pools may be causing hydraulic issues, construction of small internal baffles within the straight pools may provide the necessary energy dissipation to correct the issue. Design and testing of this type of improvement could be carried out initially with a CFD computer model of a short segment of the ladder with differing baffle configurations. These baffles would be likely be constructed of galvanized steel structural shapes (such as a set of three

4"x4" angles) welded to a plate that is bolted to the bottom of the fish ladder concrete (see Figure 8). Experimentation with different configurations could also be accomplished as a full-scale model in select pools of the ladder itself.

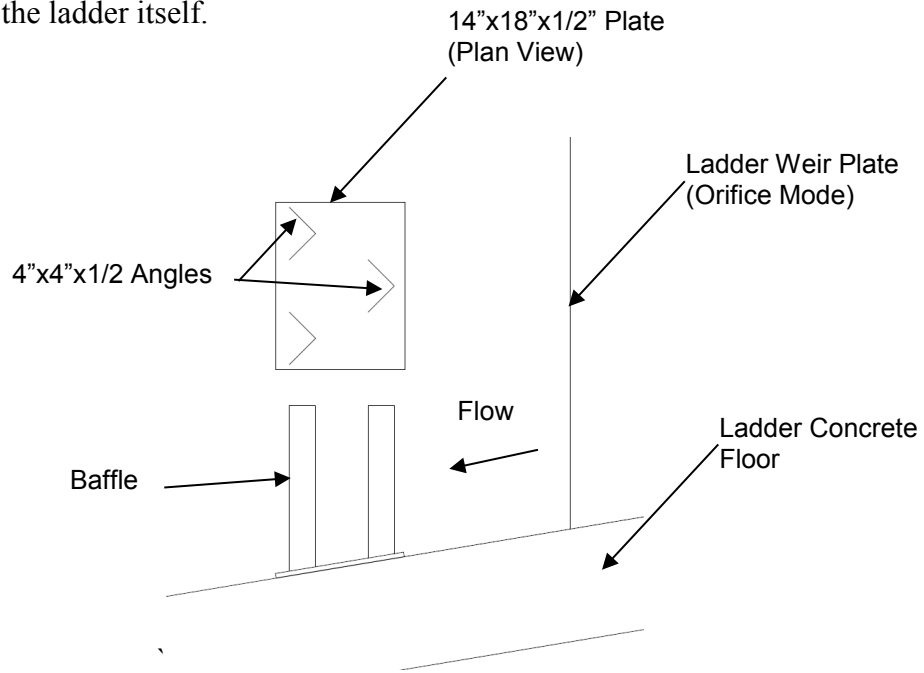

Figure 8: Conceptual retrofit baffle installed approximately 18 inches downstream of weir plate.

7.0 Conclusions

The Thompson Falls fish ladder has allowed successful passage of more than 31,000 fish since 2011. It has been shown to pass salmonid and non-salmonid fish over a range of tailwater conditions. However, modifications to the ladder could be made to improve ladder hydraulics and increase the rate of successful passage. These improvements include refining flow rates down the ladder and installing baffle type structures to dissipate energy. Additional data, through the installation of additional PIT tag antenna would be beneficial to further pinpoint areas of the ladder which may be causing fish to not successfully navigate to the top.

Fish passage occurred in both operating modes, although more fish and more weaker swimming fish passed during orifice mode operations than in overflow weir mode. This is likely due to more challenging hydraulic conditions when the ladder is operated in the weir mode. If the ladder is to be operated in overflow weir mode, extreme attention needs to be paid to the operating level in Pool 45, as an operating level approximately 0.6 feet above the recommended Pool 45 operating level doubles the pool-to-pool flow in the ladder.

Unsteady flow conditions were identified in both operating modes. Unsteady flow included energy carry-over in flow from upper pools of straight pool runs, creating a drawdown condition, with lower differentials and higher velocities for both orifice and weir operations. Turning pools had backwater characteristics, where greater depths and pool volumes absorbed energy.

Two operational issues played potentially appreciable roles in depressing fish passage in 2017:

- Operational control of the pool 45 water surface at even 0.25 feet higher than the design El. 2393.0 water surface increases flow in lower pools by as much as 40% in the weir mode, and likely blocks weaker fish from passing. Pool 45 should not be operated at above El. 2393.0 in the weir mode.
- PIT-tag detectors in weirs 7/8 and 8/9 were designed for orifice flow but were left in place during the 2017 weir mode operation. This created potentially major localized hydraulic discontinuity in 2017 and may have blocked passage of weaker swimming fish. The same PIT detectors should not be used in the future with weir operations.

8.0 References

Federal Energy Regulatory Commission. FERC. 2009. Order Approving Construction and Operation of Fish Passage Facility. February 12, 2009. 126 FERC 62,105.

NorthWestern Energy, 2016. 2015 Annual Report, Fish Passage Project, Thompson Falls Hydroelectric Project, FERC Project Number 1869. Submitted to Federal Energy Regulatory Commission, March 2016.

National Marine Fisheries Service (NMFS), Northwest Region, 2011. Anadromous Salmonid Passage Facility Design. February 2011.

Appendix A - Velocity Measurement Summaries in Orifice Mode

Thompson Falls Fish Ladder
 Measured Velocities (ft/s) in Orifice Mode
 8/2/2016 Pool 45 at El. 2393.6

Legend	-2	and lower
	0	
	2	and higher

- Notes: 1. Upper probe placed at 3'-6" depth from bottom. Lower probe placed at 1'-9" depth from bottom. Bottom probe placed at 6" depth from bottom
 2. Left and right are based on looking from upstream (high) to downstream (low)
 3. Water level in Pool 45 at 93.7' gauge height

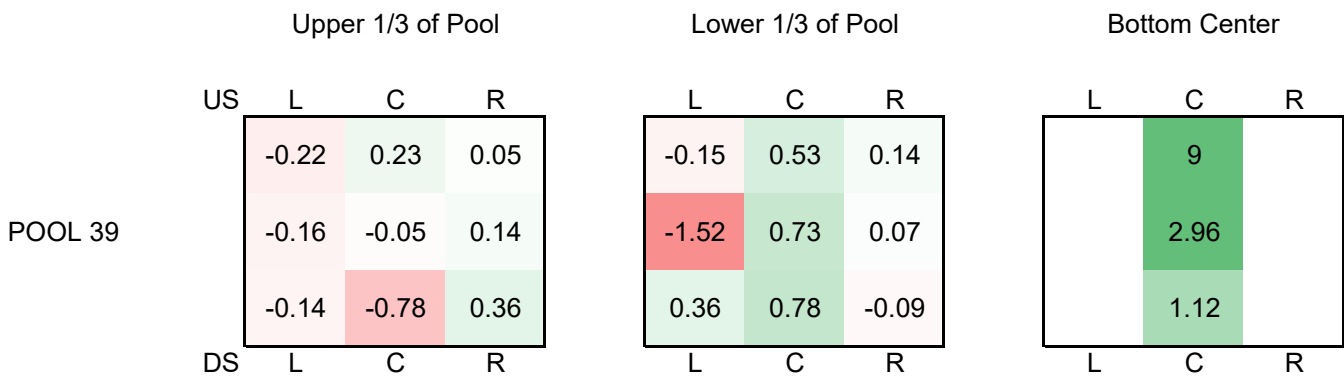
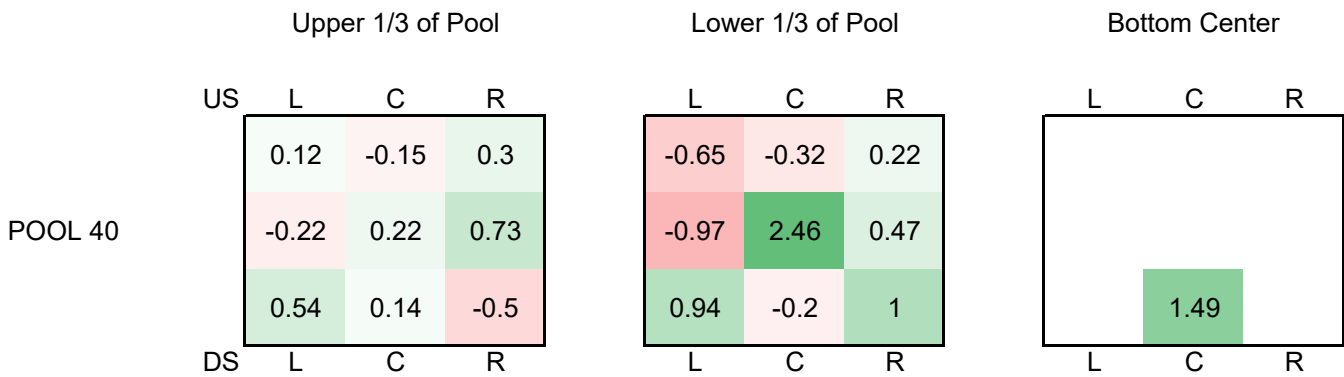
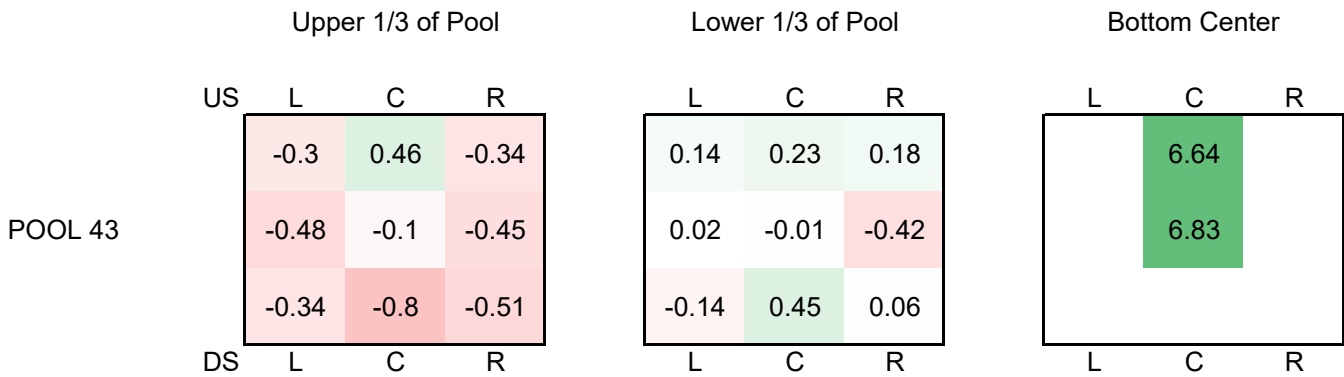

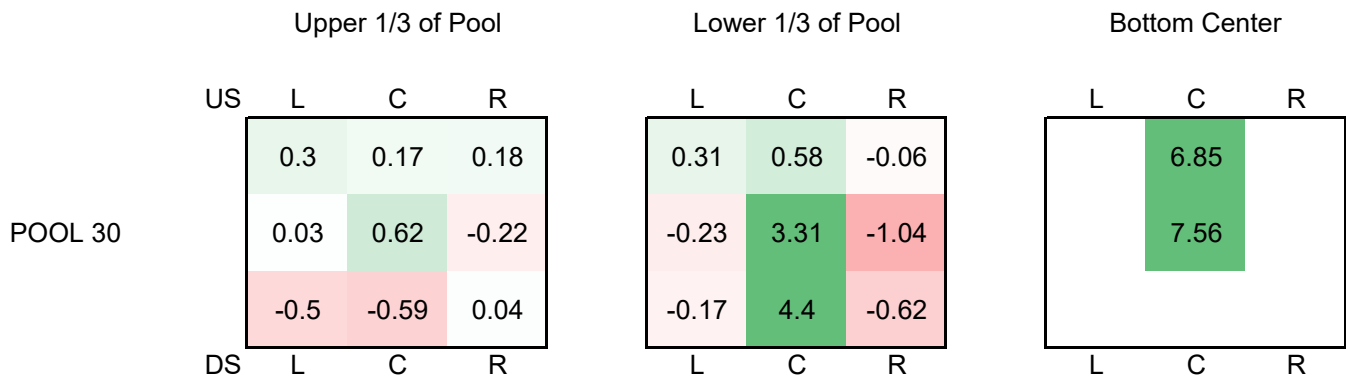
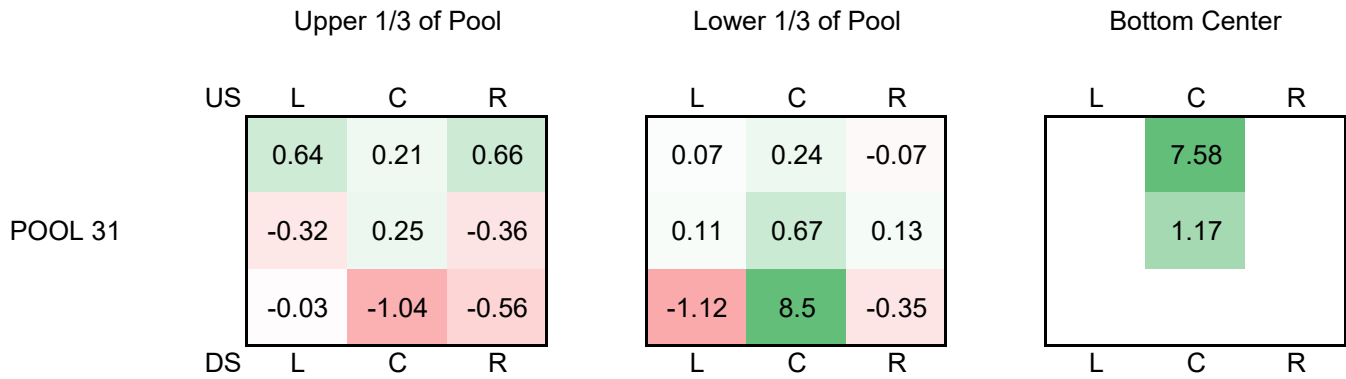
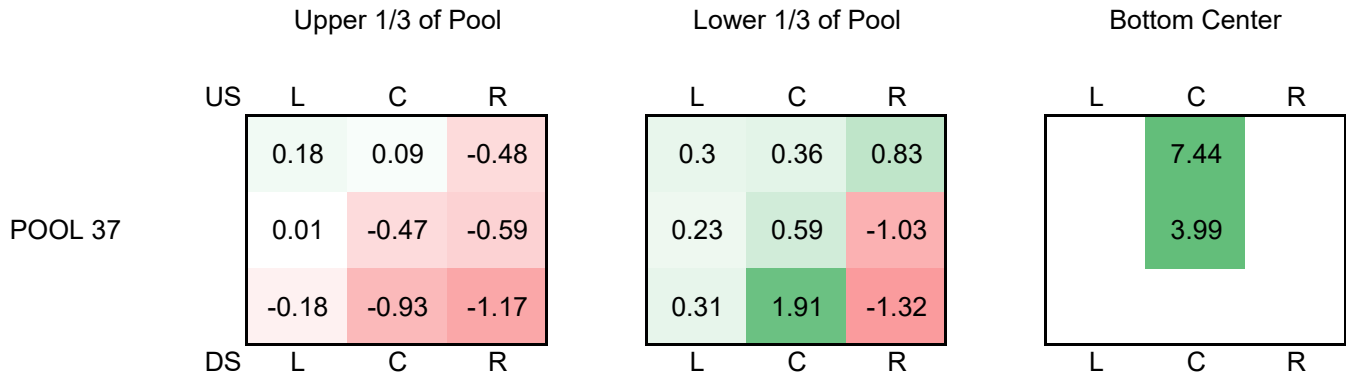

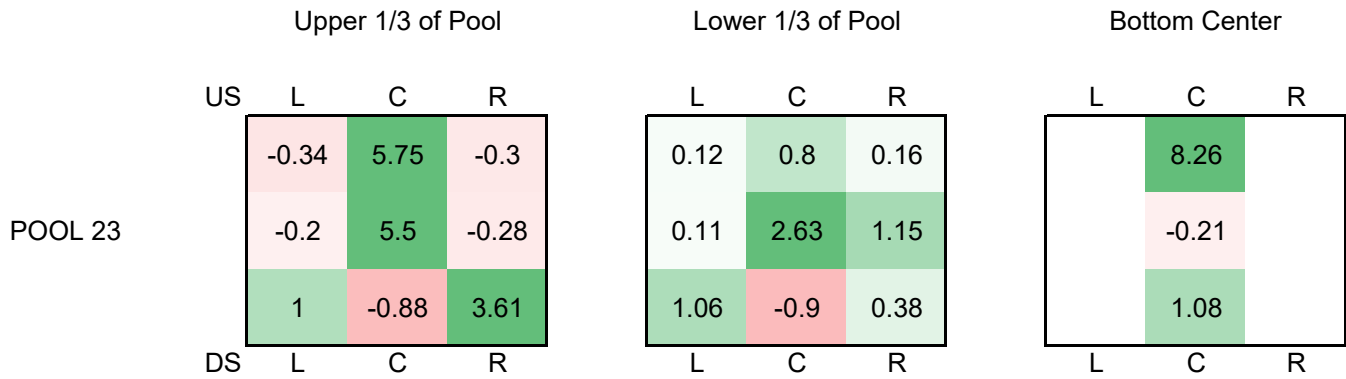
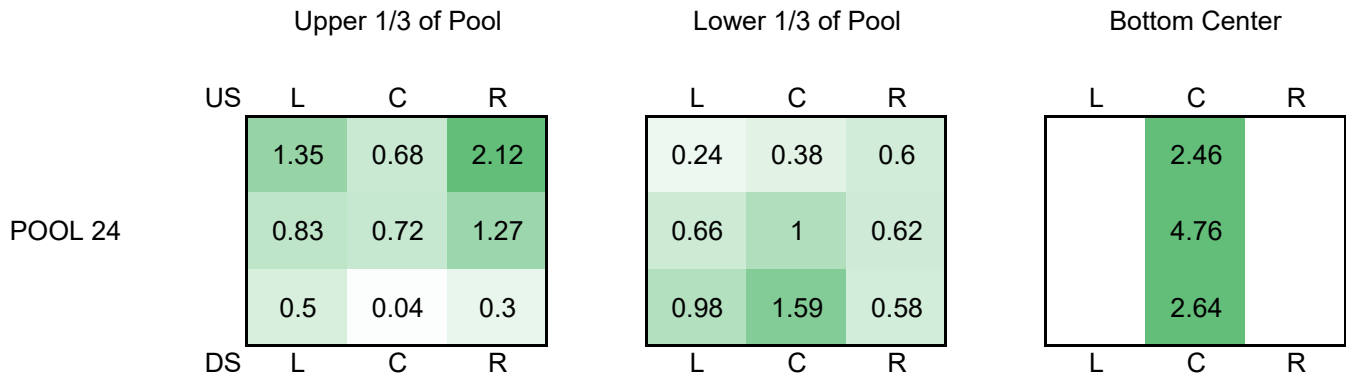
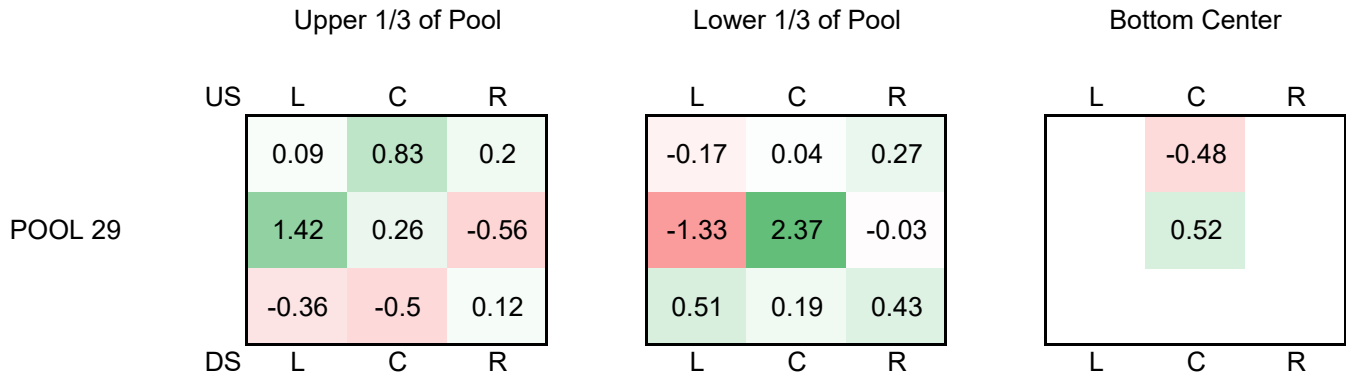

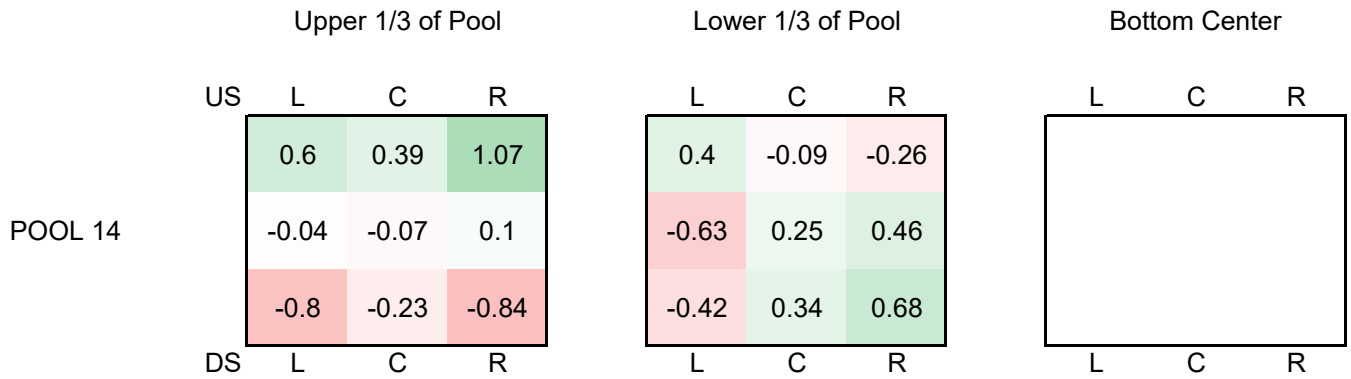
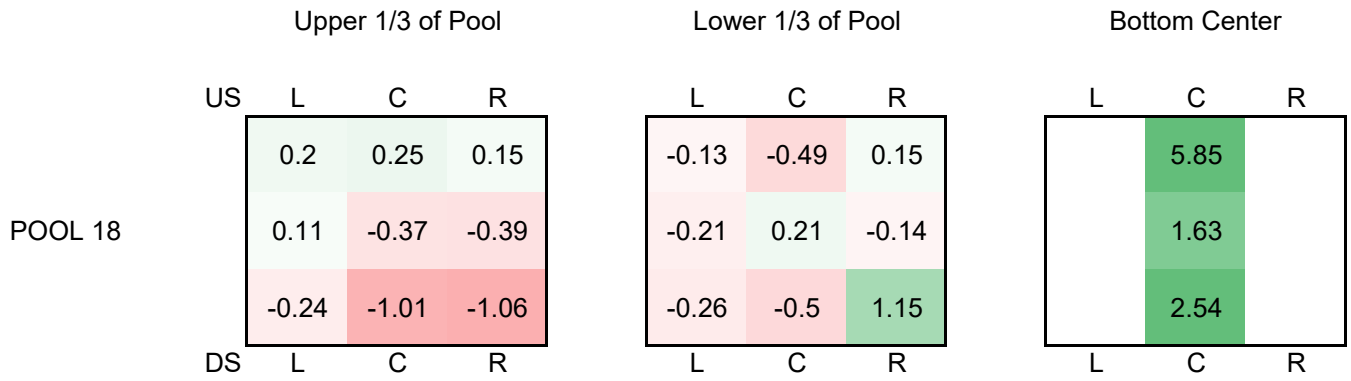
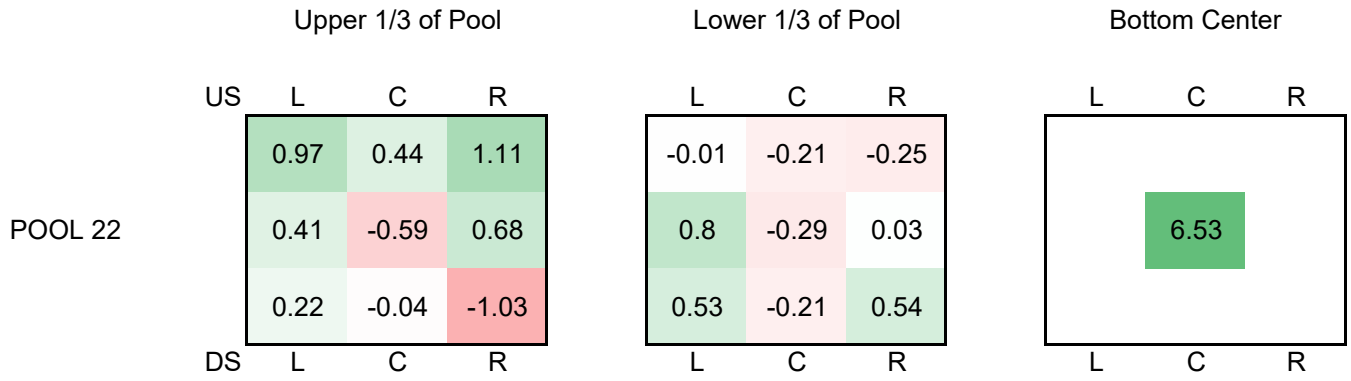

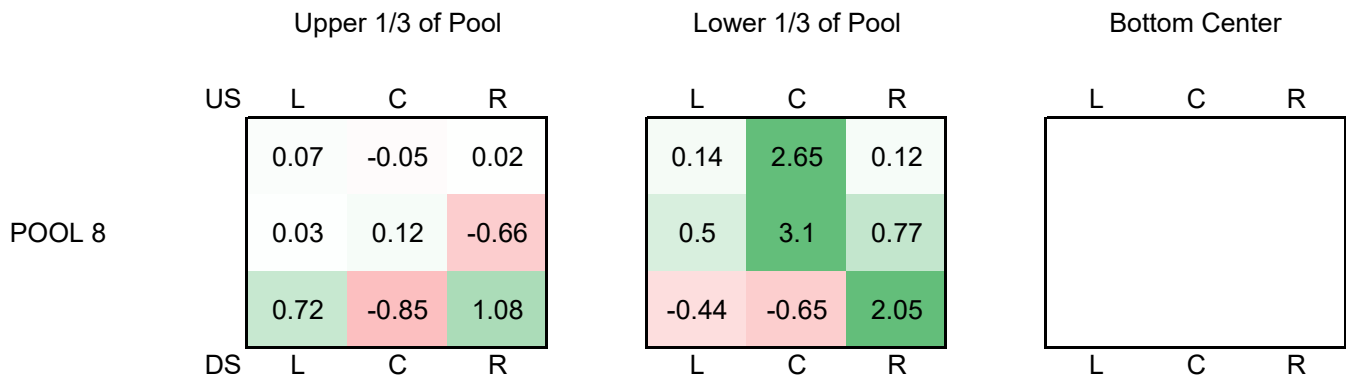
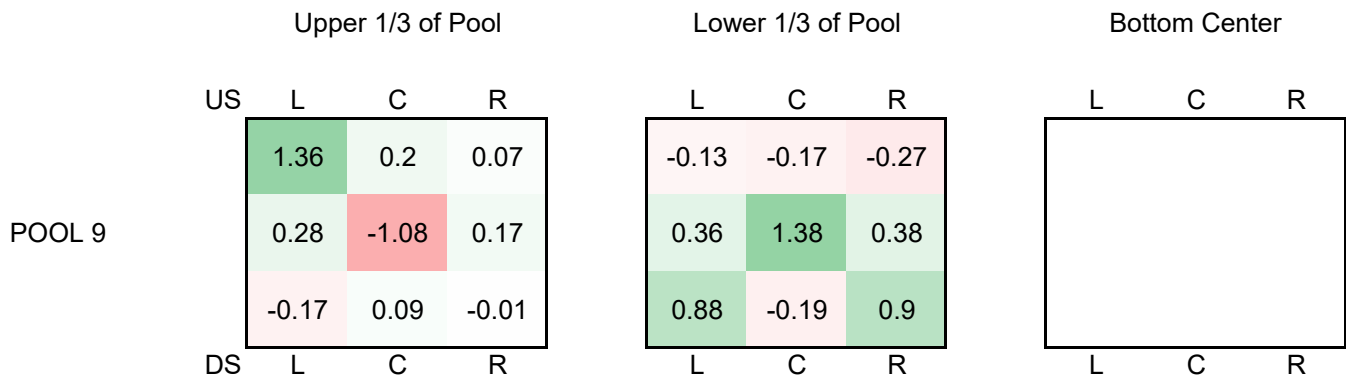
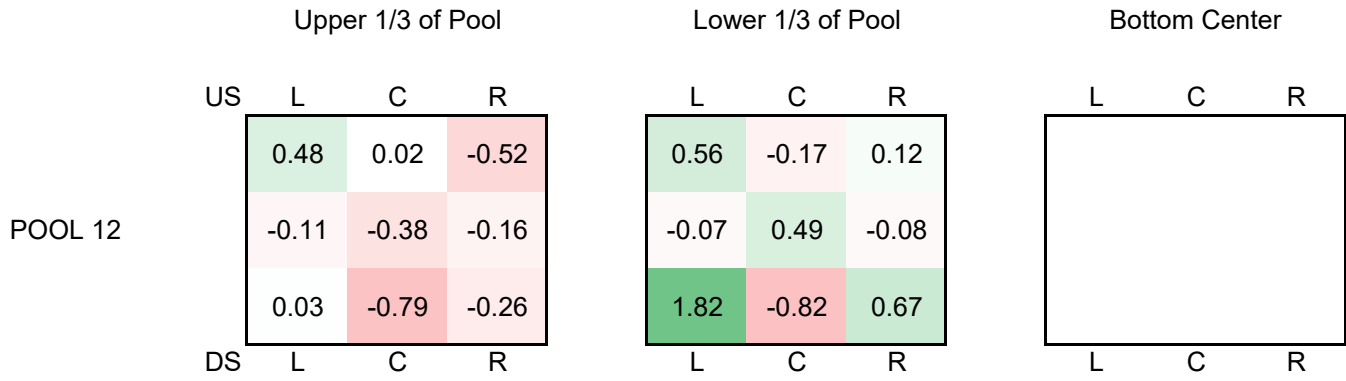

Upper 1/3 of Pool

Lower 1/3 of Pool

Bottom Center

POOL 6

US	L	C	R
	0.12	0.14	-0.14
	-0.05	0.74	-0.58
DS	L	C	R

L	C	R
-0.2	0.21	-0.13
-0.36	1.69	0.31
L	C	R

L	C	R
L	C	R

Appendix B - Velocity Measurement Summaries in Overflow Weir Mode

Thompson Falls Fish Ladder
 Measured Velocities (ft/s) in Overflow Weir Mode
 8/1/2017 Pool 45 at El. 2393.25

Legend -2 and lower
 0
2 and higher

Notes: Left and right are based on looking from upstream (high) to downstream (low)

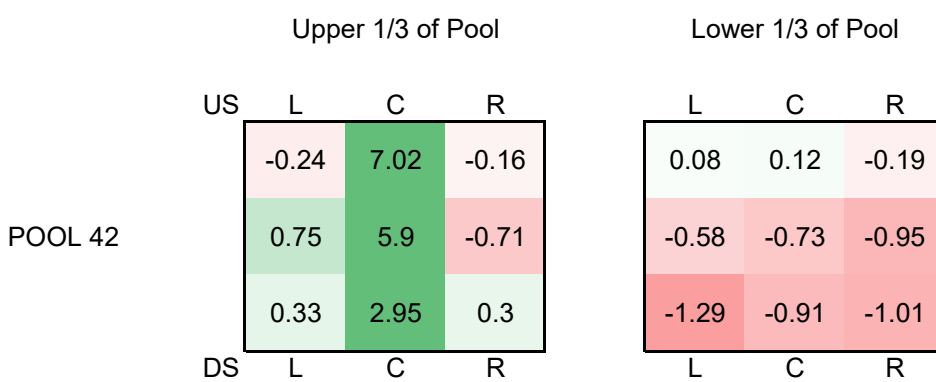
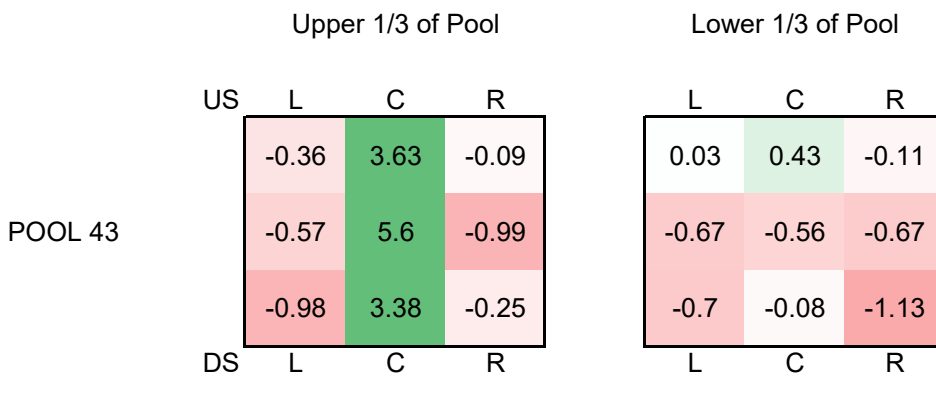
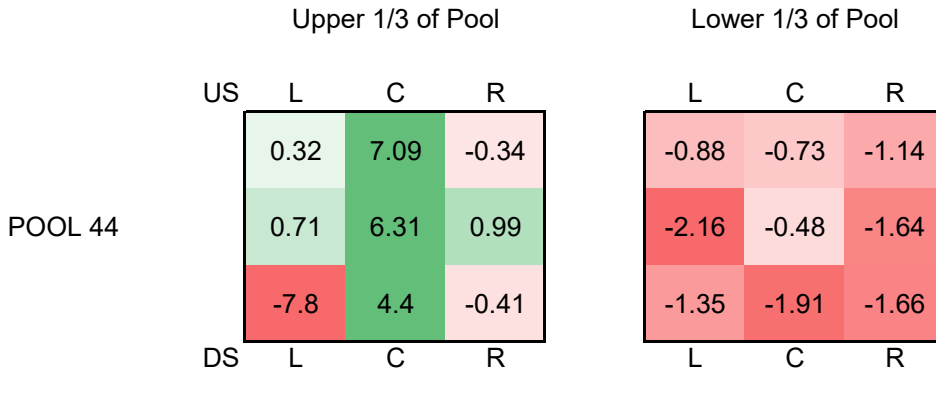

		Upper 1/3 of Pool			Lower 1/3 of Pool		
POOL 41	US	L	C	R	L	C	R
		-0.23	5.39	0.21	0.24	-0.35	0.05
		-0.32	5.96	-0.49	-0.23	-0.32	-0.95
		-0.64	4.07	-0.46	-0.91	-1.11	-0.87
DS	L	C	R	L	C	R	

		Upper 1/3 of Pool			Lower 1/3 of Pool		
POOL 40 <i>Turning Pool</i>	US	L	C	R	L	C	R
		-1.01	5.77	0.22	0.42	-0.42	-0.71
		-0.65	3.06	0.56	-0.77	0.02	-0.81
		1.29	0.92	0.18	0.03	-1.59	-0.42
DS	L	C	R	L	C	R	

		Upper 1/3 of Pool			Lower 1/3 of Pool		
POOL 39 <i>Turning Pool</i>	US	L	C	R	L	C	R
		-0.7	4.95	1.1	-0.03	-1.04	-1.08
		-0.96	7.04	0.4	-1.87	-0.67	-1.42
		1.15	1.63	0.29	0.85	-0.75	-0.45
DS	L	C	R	L	C	R	

		Upper 1/3 of Pool			Lower 1/3 of Pool		
POOL 38	US	L	C	R	L	C	R
		0.1	6.65	0.28	-0.89	-3.27	-0.93
		0.32	3.38	2.26	0.04	-0.88	-1.76
		0.44	2.9	-0.2	-1.73	-0.82	-1.67
DS	L	C	R	L	C	R	

		Upper 1/3 of Pool			Lower 1/3 of Pool		
POOL 37	US	L	C	R	L	C	R
		0.05	5.85	0.2	0	0.38	-0.6
		-1.05	4.45	0.23	-0.69	-0.67	-0.26
		0.02	3.62	-0.29	-0.84	-0.59	-0.91
DS	L	C	R	L	C	R	

		Upper 1/3 of Pool			Lower 1/3 of Pool		
POOL 36	US	L	C	R	L	C	R
		0.33	8.96	-0.22	-0.82	-0.15	-0.17
		-0.35	6.39	-0.55	-0.36	0.3	-0.95
		-1.17	3.25	-0.85	-0.31	-0.62	-1.35
DS	L	C	R	L	C	R	

		Upper 1/3 of Pool			Lower 1/3 of Pool		
POOL 35	US	L	C	R	L	C	R
		1.16	7.49	-0.49	0.16	0.05	-0.46
		-0.81	4.94	-0.89	-1.03	-0.67	-0.86
		-0.06	3.83	-1.1	-0.74	-0.79	-1.2
	DS	L	C	R	L	C	R

		Upper 1/3 of Pool			Lower 1/3 of Pool		
POOL 34 <i>Turning Pool</i>	US	L	C	R	L	C	R
		0.47	4.94	0.5	0.47	-0.55	-0.45
		-0.08	2.15	-0.04	-0.88	-0.87	-1.23
		0.17	0.99	1.53	-0.23	-0.95	-0.54
	DS	L	C	R	L	C	R

		Upper 1/3 of Pool			Lower 1/3 of Pool		
POOL 33 <i>Turning Pool</i>	US	L	C	R	L	C	R
		0.28	8.34	-0.65	0.62	-0.22	-0.19
		0.82	4.37	-0.72	-1.29	0.55	-1.52
		0.48	3.31	1.42	-0.14	-0.73	0.51
	DS	L	C	R	L	C	R

Upper 1/3 of Pool

Lower 1/3 of Pool

POOL 32

US	L	C	R
	0.62	7.86	0.95
	-0.23	5.15	1.02
	0.17	4.02	1.06
DS	L	C	R

L	C	R
0.18	0.81	-0.05
-0.8	0.15	-0.94
-1.17	-1.24	-1.05
L	C	R

Upper 1/3 of Pool

Lower 1/3 of Pool

POOL 31

US	L	C	R
	0.41	7.01	0.24
	0.2	6.71	-1.27
	1.08	3.66	-0.51
DS	L	C	R

L	C	R
-0.06	0.34	-0.19
-0.96	0.01	-1.13
-0.87	-0.55	-1.37
L	C	R

Upper 1/3 of Pool

Lower 1/3 of Pool

POOL 30

US	L	C	R
	-0.23	5.43	-0.04
	-0.71	5.53	-0.66
	-0.07	3.71	-0.08
DS	L	C	R

L	C	R
-0.27	1.78	-0.48
-0.67	-0.57	-0.75
-1.25	-0.44	-1.07
L	C	R

		Upper 1/3 of Pool			Lower 1/3 of Pool		
POOL 29	US	L	C	R	L	C	R
		-0.03	3.08	0.13	0.39	-1.12	0.15
<i>Turning Pool</i>	DS	L	C	R	L	C	R
		0.09	3.8	0.56	-0.63	-0.96	-0.83
		1.03	1.93	0.07	-0.59	-0.61	-0.9

		Upper 1/3 of Pool			Lower 1/3 of Pool		
POOL 28	US	L	C	R	L	C	R
		-0.17	5.53	0.11	-1.12	0.05	-0.16
<i>Turning Pool</i>	DS	L	C	R	L	C	R
		-0.84	3.18	0.52	-2.08	-0.58	-0.97
		0.43	1.32	-0.16	0.77	-0.97	-0.56

		Upper 1/3 of Pool			Lower 1/3 of Pool		
POOL 27	US	L	C	R	L	C	R
		0.08	2.56	0.27	-1.06	-0.6	0.28
<i>Turning Pool</i>	DS	L	C	R	L	C	R
		2.51	3.12	0.07	-0.78	-1.7	-1.1
		-0.6	1.46	0.69	-1.22	-1.42	-0.92

		Upper 1/3 of Pool			Lower 1/3 of Pool		
POOL 26 <i>Turning Pool</i>	US	L	C	R	L	C	R
		0.33	6.36	-1.17	-0.48	-0.1	0.91
		0.75	3.01	-0.65	-0.81	-0.82	-1.44
		0.58	1.65	0.93	-0.07	-0.57	0.33
DS	L	C	R	L	C	R	

		Upper 1/3 of Pool			Lower 1/3 of Pool		
POOL 25 <i>Turning Pool</i>	US	L	C	R	L	C	R
		0.13	3.82	0.26	-0.76	0.29	0.59
		-0.1	1.81	0.22	-0.88	-0.1	-0.14
		0.53	1.07	-0.28	0.87	-0.41	-0.81
DS	L	C	R	L	C	R	

		Upper 1/3 of Pool			Lower 1/3 of Pool		
POOL 24 <i>Turning Pool</i>	US	L	C	R	L	C	R
		-0.68	4.55	0.31	-0.86	1.39	-0.12
		-1.63	3.93	0.9	-1.48	1.75	-0.57
		0.78	2.23	0.33	-1.28	-0.23	-0.23
DS	L	C	R	L	C	R	

		Upper 1/3 of Pool			Lower 1/3 of Pool		
POOL 23	US	L	C	R	L	C	R
		0.2	2.75	-0.12	0.98	-0.55	-0.84
		0.35	3.72	2.36	-0.72	0.42	-0.94
		0.46	4.29	-0.12	-0.73	-0.97	-1.04
	DS	L	C	R	L	C	R

		Upper 1/3 of Pool			Lower 1/3 of Pool		
POOL 22 <i>Turning Pool</i>	US	L	C	R	L	C	R
		-0.05	3.97	-0.38	40	-0.42	-0.68
		0.56	1.54	-0.26	-0.54	-0.11	-0.98
		1.79	3.2	-0.09	1.19	-1	-0.15
	DS	L	C	R	L	C	R

		Upper 1/3 of Pool			Lower 1/3 of Pool		
POOL 21	US	L	C	R	L	C	R
		-0.53	4.63	-0.47	0.24	-0.43	-0.36
		0.73	4.02	-0.33	-0.57	0.65	-1.16
		1.31	3.07	-0.12	-0.33	-0.98	-1.05
	DS	L	C	R	L	C	R

		Upper 1/3 of Pool			Lower 1/3 of Pool		
POOL 20	US	L	C	R	L	C	R
		<i>Turning Pool</i>	0.54	7.91	-0.53	0.03	0.88
		0.94	3.14	-0.28	-0.81	-0.82	-1.6
	DS	-0.16	2.22	0.77	-0.24	-0.92	-0.92
		L	C	R	L	C	R

		Upper 1/3 of Pool			Lower 1/3 of Pool		
POOL 19	US	L	C	R	L	C	R
			0.52	6.11	0.36	-0.81	-0.77
		2.94	6.46	0.66	-1.46	-1.06	-1.16
	DS	-1.01	3.1	1.11	-1.3	-1.07	-1.86
		L	C	R	L	C	R

		Upper 1/3 of Pool			Lower 1/3 of Pool		
POOL 18	US	L	C	R	L	C	R
			-0.03	4.11	-0.28	0.17	-0.19
		1.06	2.22	-0.45	-0.97	-1.04	-1.19
	DS	-1.15	3.05	0.25	-0.99	-0.66	-1.6
		L	C	R	L	C	R

		Upper 1/3 of Pool			Lower 1/3 of Pool		
POOL 17	US	L	C	R	L	C	R
			0.29	7.66	0.15	-0.19	-0.08
		-0.27	3.84	-1.23	-1.17	-0.29	-1.24
		-0.28	3.53	0.87	-0.73	-0.82	-1.85
DS		L	C	R	L	C	R

		Upper 1/3 of Pool			Lower 1/3 of Pool		
POOL 16	US	L	C	R	L	C	R
			0.65	6.87	0.03	0.67	0.89
		0.22	6.64	-0.63	-0.39	-0.19	-1.2
		0.07	3.61	-0.66	-0.77	-0.98	-1.24
DS		L	C	R	L	C	R

		Upper 1/3 of Pool			Lower 1/3 of Pool		
POOL 15 <i>Turning Pool</i>	US	L	C	R	L	C	R
			n/a	n/a	n/a	n/a	n/a
		n/a	n/a	-1.16	n/a	n/a	-0.61
		-0.02	2.18	0.45	1.13	-1.03	-1.05
DS		L	C	R	L	C	R

		Upper 1/3 of Pool			Lower 1/3 of Pool		
POOL 14	US	L	C	R	L	C	R
		<i>Turning Pool</i>	-1.62	6.38	-0.38	-1.04	-0.26
		0.83	1.21	-0.03	-0.92	0.33	-2.28
	DS	-0.47	1.07	0.64	0.35	-1.01	-0.34
		L	C	R	L	C	R

		Upper 1/3 of Pool			Lower 1/3 of Pool		
POOL 13	US	L	C	R	L	C	R
			-0.16	7.1	-0.32	-0.16	-0.14
		0.98	3.52	0.57	-1.37	-1.14	-1.55
	DS	-0.19	3.17	-0.16	-1.21	-0.75	-1.92
		L	C	R	L	C	R

		Upper 1/3 of Pool			Lower 1/3 of Pool		
POOL 12	US	L	C	R	L	C	R
			-0.03	4.28	0.21	-0.3	-0.71
		0.41	4.96	-1.11	-0.69	-0.96	-1.2
	DS	-0.12	4.42	-0.64	-0.75	-1.09	-1.11
		L	C	R	L	C	R

		Upper 1/3 of Pool			Lower 1/3 of Pool		
POOL 11	US	L	C	R	L	C	R
		-0.27	7.61	-0.15	-0.2	1.6	0.17
		-1.27	5	-0.76	-0.87	-0.76	1.01
		-0.57	3.68	-0.27	-1.04	-1.25	-0.94
	DS	L	C	R	L	C	R

		Upper 1/3 of Pool			Lower 1/3 of Pool		
POOL 10 <i>Turning Pool</i>	US	L	C	R	L	C	R
		-0.25	6.74	0.1	0.87	-0.53	-1.05
		0.32	0.07	0.38	-0.49	-1.09	-0.84
		0.63	1.49	-0.14	-0.98	-0.11	-0.97
	DS	L	C	R	L	C	R

		Upper 1/3 of Pool			Lower 1/3 of Pool		
POOL 9 <i>Turning Pool</i>	US	L	C	R	L	C	R
		-0.78	4.49	-0.16	-1.3	-1.05	-0.56
		-0.3	2.9	-0.4	-0.13	-0.14	0.18
		1.65	-0.83	-0.11	1.18	3.55	0.82
	DS	L	C	R	L	C	R

Upper 1/3 of Pool

Lower 1/3 of Pool

POOL 8
Orfice Mode

US	L	C	R
	-0.08	-1.06	0.96
	0.18	-0.82	0.43
DS	-0.87	-1.55	-0.15
	L	C	R

L	C	R
-0.74	5.66	-0.32
1.24	0.52	-0.57
-1.38	3.58	-1.43
L	C	R

Upper 1/3 of Pool

Lower 1/3 of Pool

POOL 7
Orfice Mode

US	L	C	R
	0.69	0.08	-3.51
	0.22	1.31	0.34
DS	0.2	2.91	-0.92
	L	C	R

L	C	R
0.88	4.6	-1.42
1	0.9	-2
0.09	-0.42	-1.99
L	C	R